

Features:

- Isolated mounting base 2500V~
- Pressure contact technology with
Increased power cycling capability
- Space and weight savings

Typical Applications

- AC/DC Motor drives
- Various rectifiers
- DC supply for PWM inverter

$I_{F(AV)}$ **500A**
 V_{RRM} **600~1800V**
 I_{FSM} **$19A \times 10^3$**
 I^2t **$1805A^2 S \times 10^3$**



SYMBOL	CHARACTERISTIC	TEST CONDITIONS	T _j (°C)	VALUE			UNIT
				Min	Type	Max	
I _{F(AV)}	Mean forward current	180° half sine wave 50Hz Single side cooled, T _C =100°C	150			500	A
I _{F(RMS)}	RMS forward current		150			785	A
V _{RRM}	Repetitive peak reverse voltage	V _{RRM} tp=10ms V _{RSM} = V _{RRM} +100V	150	600		1800	V
I _{RRM}	Repetitive peak current	at V _{RRM}	150			45	mA
I _{FSM}	Surge forward current	10ms half sine wave	150			19.0	KA
I ² t	I ² T for fusing coordination	V _R =0.6V _{RRM}					1805
V _{FO}	Threshold voltage		150			0.75	V
r _F	Forward slop resistance						0.28
V _{FM}	Peak forward voltage	I _{FM} =1800A	25			1.50	V
R _{th(j-c)}	Thermal resistance Junction to case	At 180°sine' Single side cooled				0.065	°C /W
R _{th(c-h)}	Thermal resistance case to heatsink	At 180° sine' Single side cooled				0.024	°C /W
V _{iso}	Isolation voltage	50Hz, R.M.S, t=1min, I _{iso} :1mA(max)		2500			V
F _m	Terminal connection torque(M10)				12		N·m
	Mounting torque(M6)				6		N·m
T _{stg}	Stored temperature			-40		125	°C
W _t	Weight				2300		g
Outline	408F3/410F3/433F2						

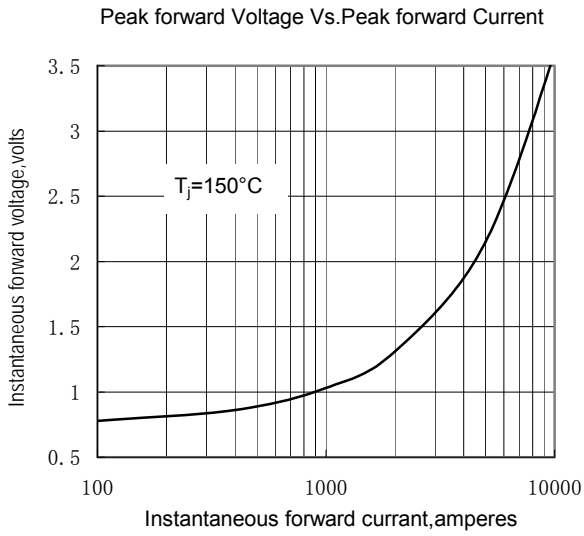

Fig.1

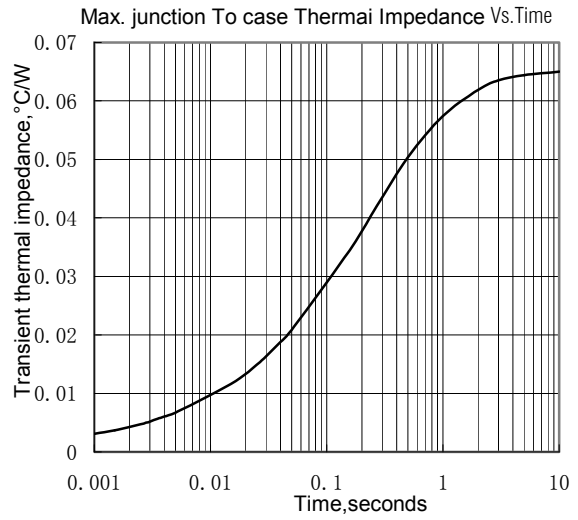

Fig.2

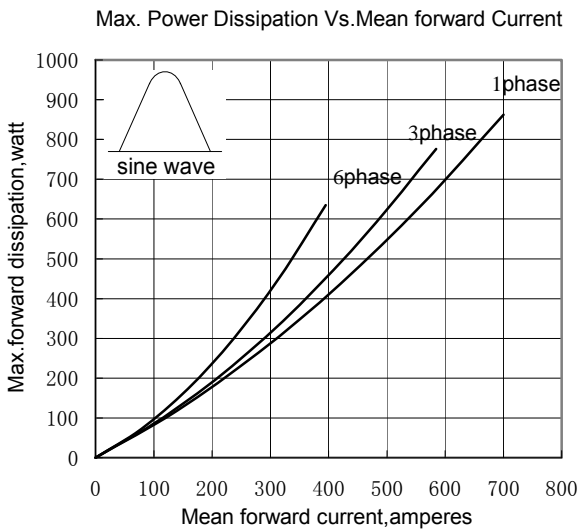

Fig.3

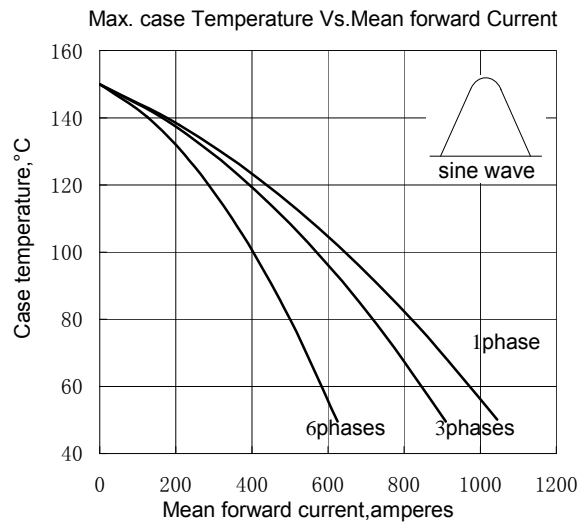

Fig.4

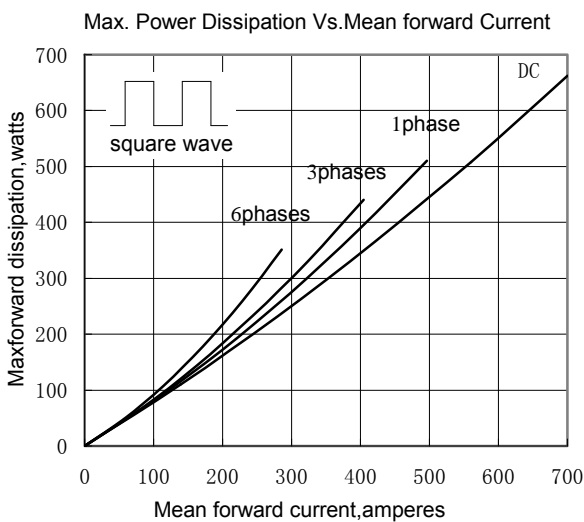

Fig.5

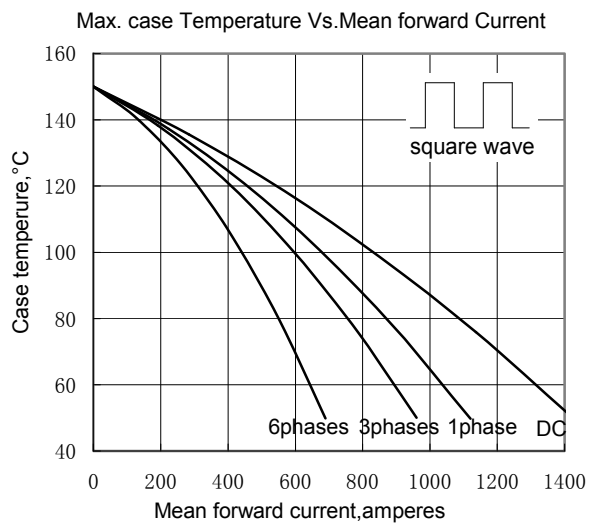

Fig.6

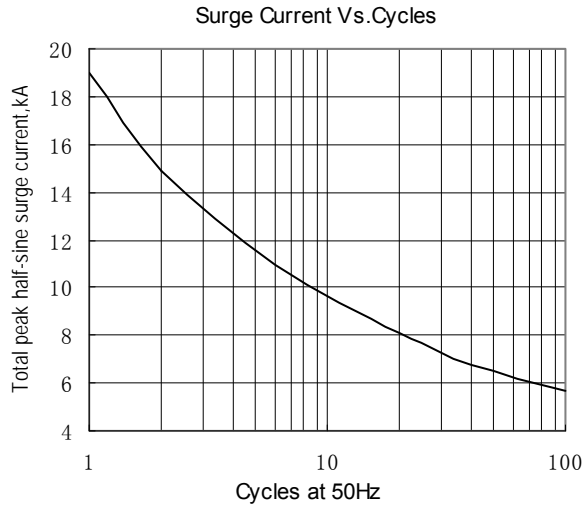

Fig.7

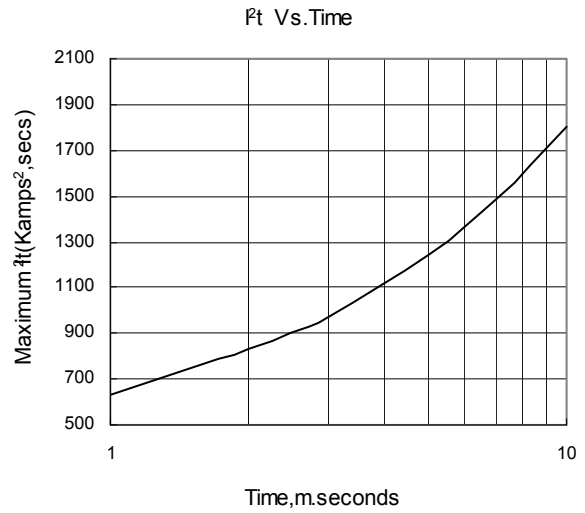
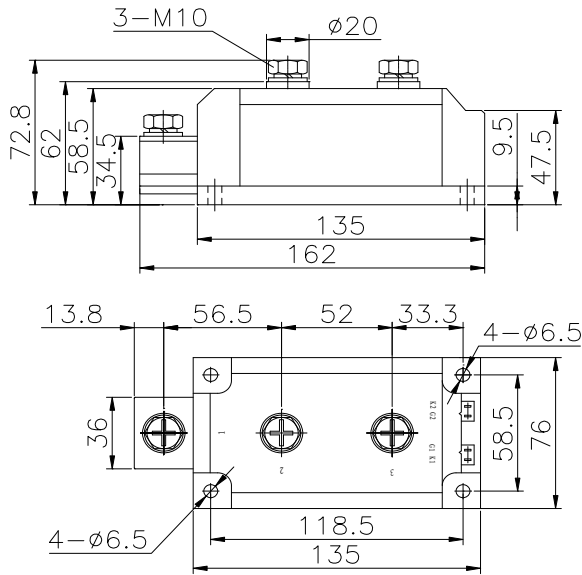

Fig.8

Outline:



408F3

