

### Features:

- Isolated mounting base 2500V~
- Pressure contact technology with  
Increased power cycling capability
- Space and weight savings

### Typical Applications

- AC/DC Motor drives
- Various rectifiers
- DC supply for PWM inverter

$I_{T(AV)}$             **250A**  
 $V_{DRM}/V_{RRM}$     **600~1800V**  
 $I_{TSM}$                  **$9.0A \times 10^3$**   
 $I^2t$                      **$405A^2 S \times 10^3$**



SYMBOL	CHARACTERISTIC	TEST CONDITIONS	T <sub>J</sub> (°C)	VALUE			UNIT
				Min	Type	Max	
$I_{T(AV)}$	Mean on-state current	180° half sine wave 50Hz Single side cooled, T <sub>c</sub> =85°C	125			250	A
$I_{T(RMS)}$	RMS on-state current		125			390	A
$V_{DRM}$ $V_{RRM}$	Repetitive peak off-state voltage Repetitive peak reverse voltage	$V_{DRM}$ & $V_{RRM}$ tp=10ms $V_{DSM}$ & $V_{RSM} = V_{DRM}$ & $V_{RRM} + 100V$ respectively	125	600		1800	V
$I_{DRM}$ $I_{RRM}$	Repetitive peak current	at $V_{DRM}$ at $V_{RRM}$	125			25	mA
$I_{TSM}$	Surge on-state current	10ms half sine wave	125			9.0	KA
$I^2t$	I <sup>2</sup> T for fusing coordination	$V_R = 60\% V_{RRM}$				405	A <sup>2</sup> s*10 <sup>3</sup>
$V_{TO}$	Threshold voltage		125			0.80	V
$r_T$	On-state slop resistance					0.85	mΩ
$V_{TM}$	Peak on-state voltage	$I_{TM} = 750A$	25			1.57	V
$dv/dt$	Critical rate of rise of off-state voltage	$V_{DM} = 67\% V_{DRM}$	125			800	V/μs
$di/dt$	Critical rate of rise of on-state current	Gate source 1.5A t <sub>r</sub> ≤ 0.5μs Repetitive	125			100	A/μs
$I_{GT}$	Gate trigger current			30		180	mA
$V_{GT}$	Gate trigger voltage	$V_A = 12V, I_A = 1A$	25	1.0		2.5	V
$I_H$	Holding current			20		180	mA
$V_{GD}$	Non-trigger gate voltage	$V_{DM} = 67\% V_{DRM}$	125	0.2			V
$R_{th(j-c)}$	Thermal resistance Junction to case	Single side cooled				0.120	°C /W
$R_{th(c-h)}$	Thermal resistance case to heatsink	Single side cooled				0.04	°C /W
$V_{iso}$	Isolation voltage	50Hz, R.M.S, t=1min, I <sub>iso</sub> : 1mA(MAX)		2500			V
$F_m$	Thermal connection torque(M8)				12		N·m
	Mounting torque(M6)				6.0		N·m
$T_{stg}$	Stored temperature			-40		125	°C
$W_t$	Weight				860		g
<b>Outline</b>	413F3/422F3						

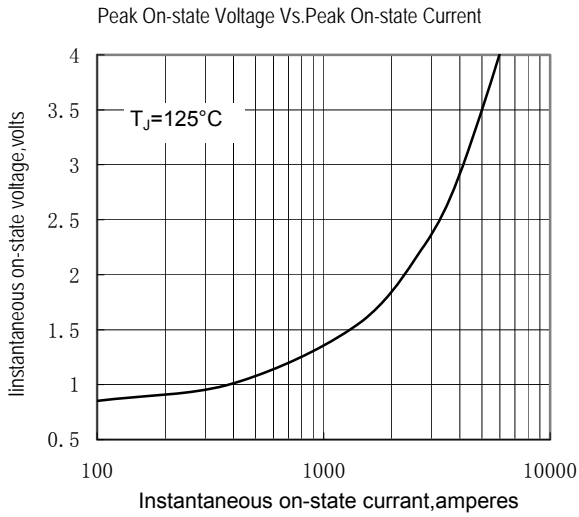


Fig.1

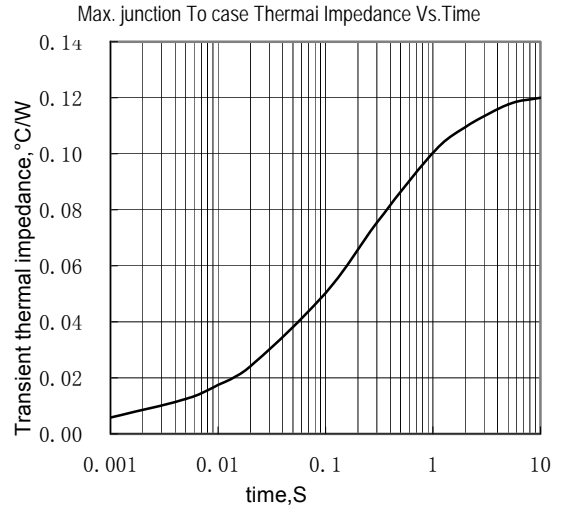


Fig.2

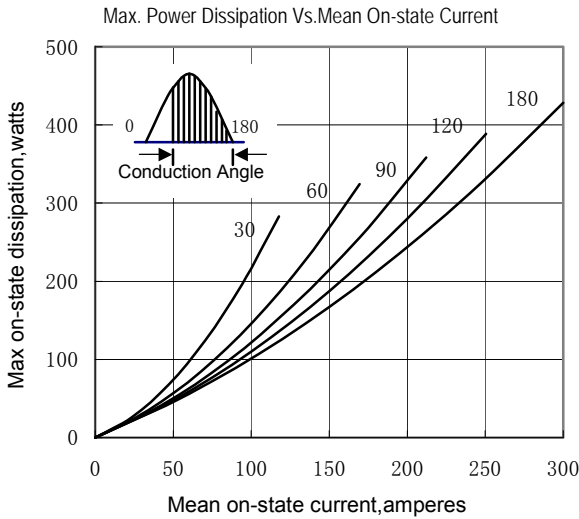


Fig.3

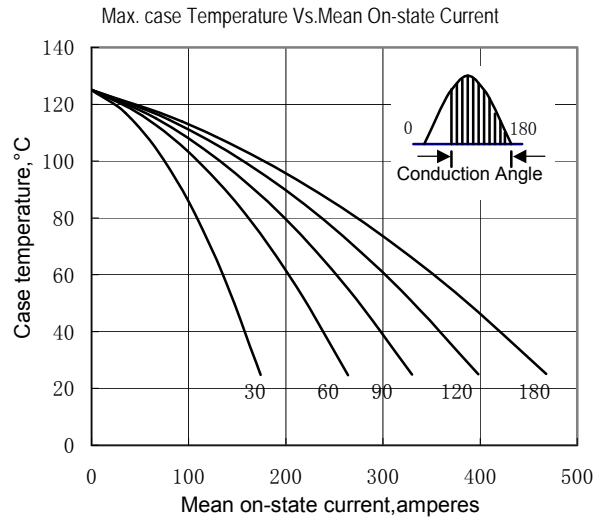


Fig.4

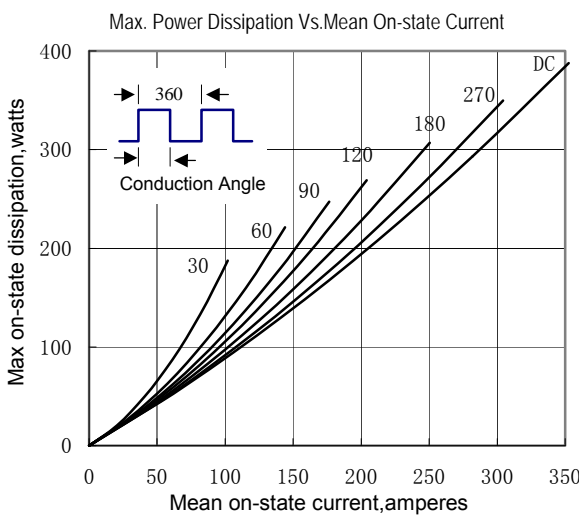


Fig.5

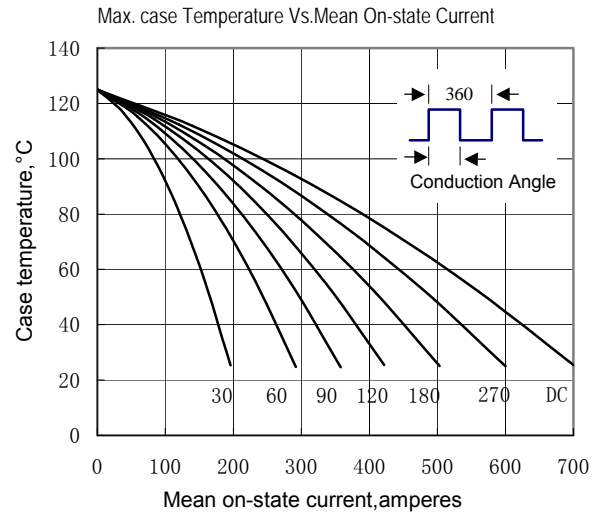
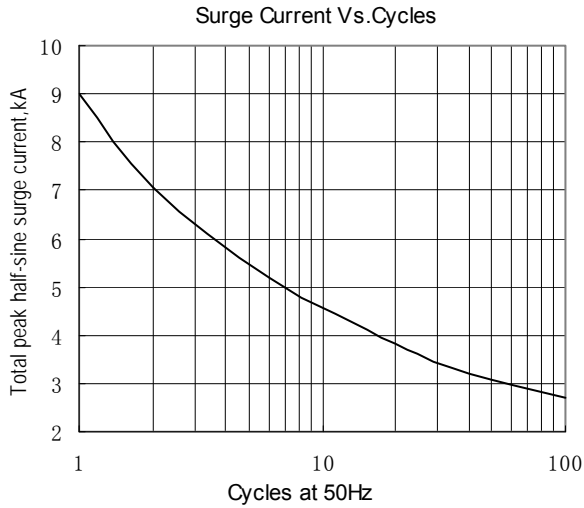
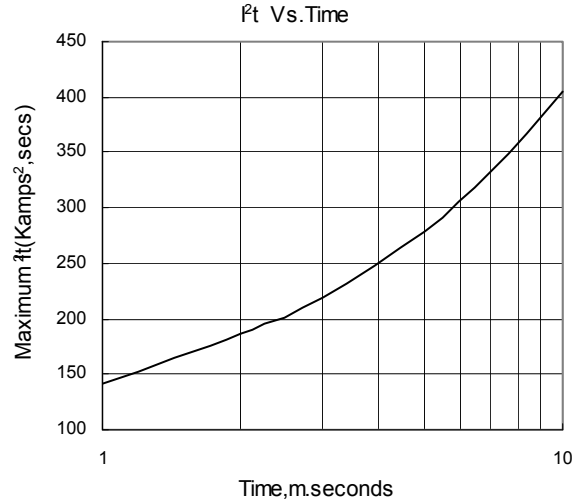


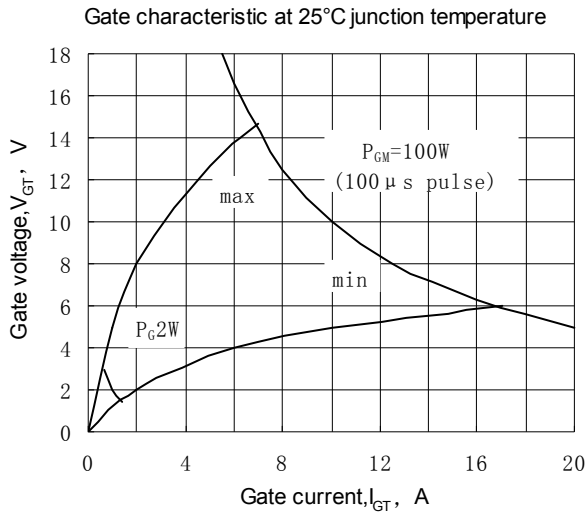
Fig.6



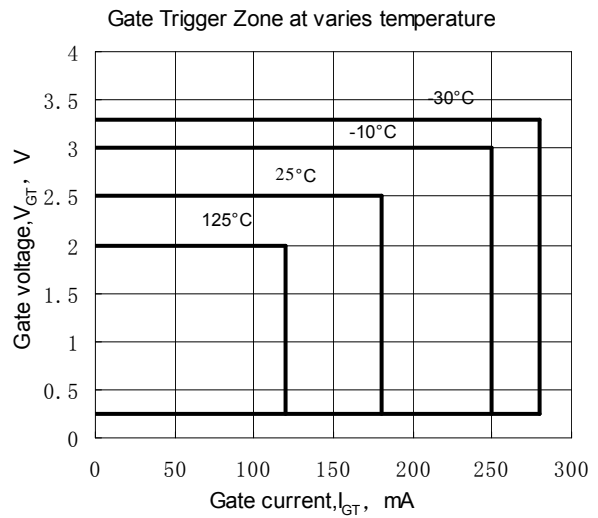
**Fig.7**



**Fig.8**

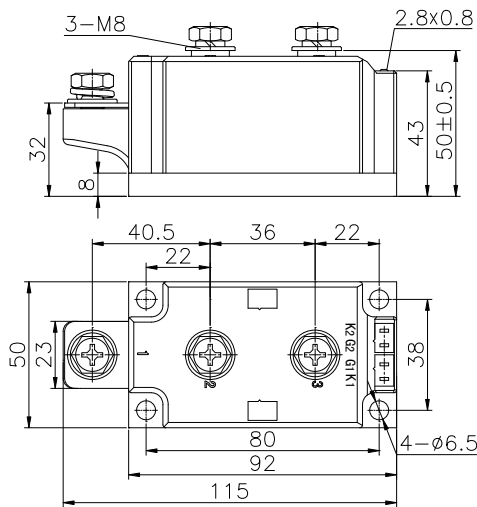


**Fig.9**



**Fig.10**

**Outline:**



**413F3**

