

### Features:

- Isolated mounting base 3600V~
- Pressure contact technology with Increased power cycling capability
- Space and weight savings

### Typical Applications

- AC/DC Motor drives
- Various rectifiers
- DC supply for PWM inverter

$I_{T(AV)}$             **300A**  
 $V_{DRM}/V_{RRM}$     **2600~3600V**  
 $I_{TSM}$                  **$9.2A \times 10^3$**   
 $I^2t$                      **$423A^2 S \times 10^3$**



SYMBOL	CHARACTERISTIC	TEST CONDITIONS	T <sub>J</sub> (°C)	VALUE			UNIT
				Min	Type	Max	
I <sub>T(AV)</sub>	Mean on-state current	180° half sine wave 50Hz Single side cooled, T <sub>c</sub> =85°C	125			300	A
I <sub>T(RMS)</sub>	RMS on-state current		125			471	A
V <sub>DRM</sub> V <sub>RRM</sub>	Repetitive peak off-state voltage Repetitive peak reverse voltage	V <sub>DRM</sub> &V <sub>RRM</sub> tp=10ms V <sub>DSM</sub> &V <sub>RSM</sub> = V <sub>DRM</sub> &V <sub>RRM</sub> +100V respectively	125	2600		3600	V
I <sub>DRM</sub> I <sub>RRM</sub>	Repetitive peak current	at V <sub>DRM</sub> at V <sub>RRM</sub>	125			50	mA
I <sub>TSM</sub>	Surge on-state current	10ms half sine wave	125			9.2	KA
I <sup>2</sup> t	I <sup>2</sup> T for fusing coordination	V <sub>R</sub> =60%V <sub>RRM</sub>					423
V <sub>TO</sub>	Threshold voltage		125			0.93	V
r <sub>T</sub>	On-state slop resistance						1.0
V <sub>TM</sub>	Peak on-state voltage	I <sub>TM</sub> =900A	25			2.45	V
dv/dt	Critical rate of rise of off-state voltage	V <sub>DM</sub> =67%V <sub>DRM</sub>	125			800	V/μs
di/dt	Critical rate of rise of on-state current	I <sub>TM</sub> =600A, Gate source 1.5A t <sub>r</sub> ≤0.5μs Repetitive	125			100	A/μs
I <sub>GT</sub>	Gate trigger current	V <sub>A</sub> =12V, I <sub>A</sub> =1A	25	30		180	mA
V <sub>GT</sub>	Gate trigger voltage			1.0		2.5	V
I <sub>H</sub>	Holding current			20		150	mA
V <sub>GD</sub>	Non-trigger gate voltage	V <sub>DM</sub> =67%V <sub>DRM</sub>	125	0.2			V
R <sub>th(j-c)</sub>	Thermal resistance Junction to case	Single side cooled				0.080	°C /W
R <sub>th(c-h)</sub>	Thermal resistance case to heat sink	Single side cooled				0.04	°C /W
V <sub>iso</sub>	Isolation voltage	50Hz, R.M.S, t=1min, I <sub>iso</sub> :1mA(MAX)		3600			V
F <sub>m</sub>	Thermal connection torque (M10)				12.0		N-m
	Mounting torque (M6)				6.0		N-m
T <sub>stg</sub>	Stored temperature			-40		140	°C
W <sub>t</sub>	Weight				1350		g
Outline	415F3						

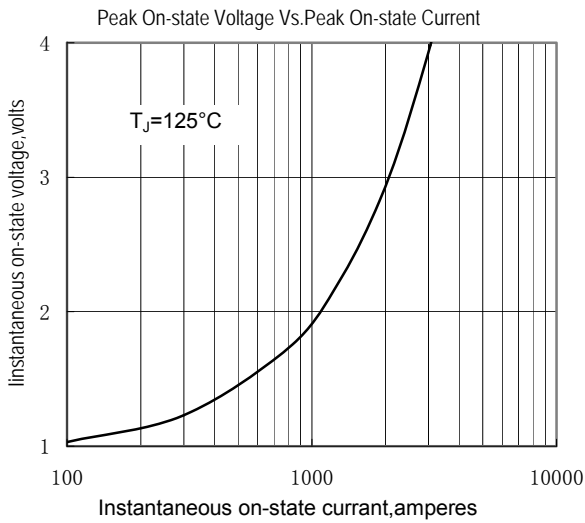

Fig.1

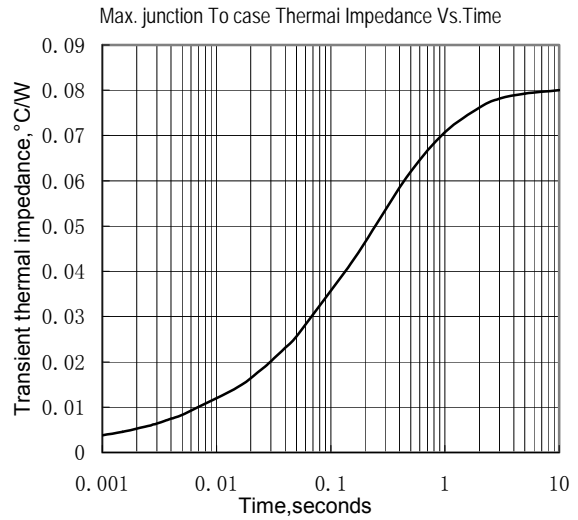

Fig.2

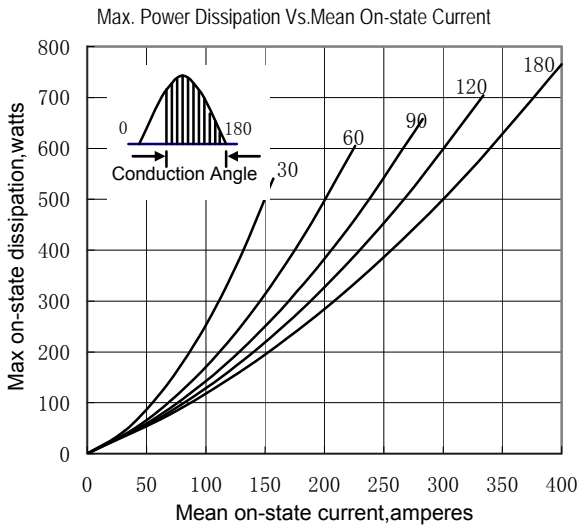

Fig.3

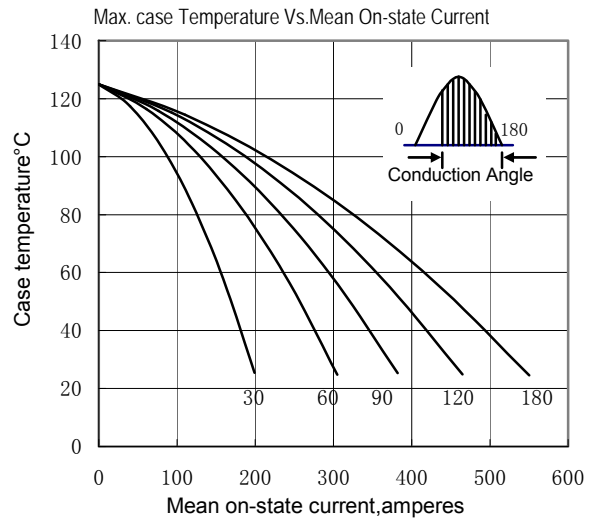

Fig.4

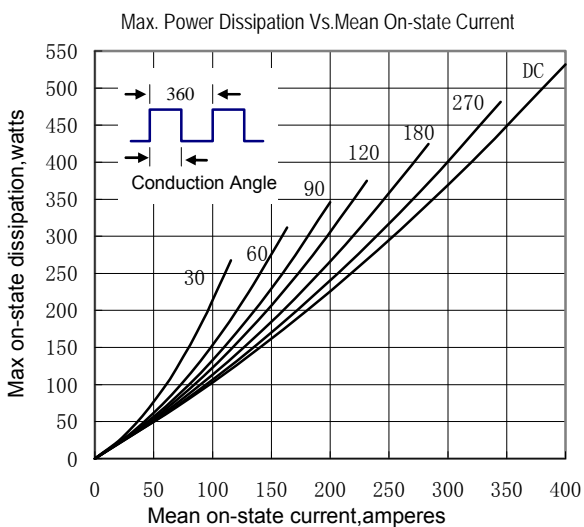

Fig.5

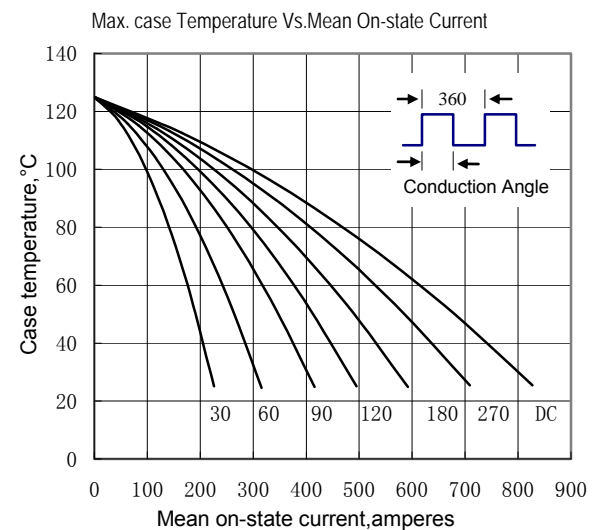

Fig.6

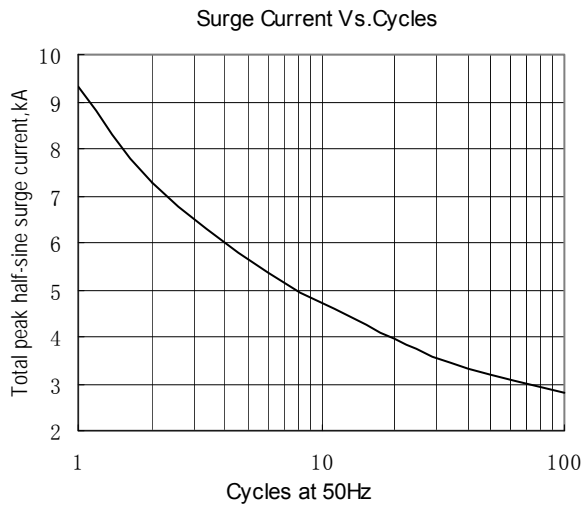

Fig.7

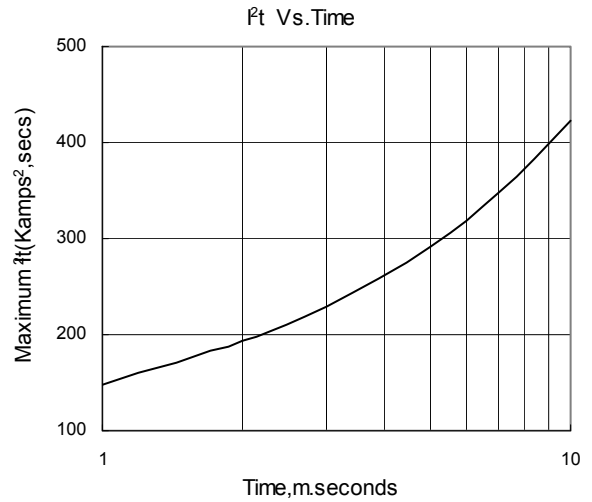

Fig.8

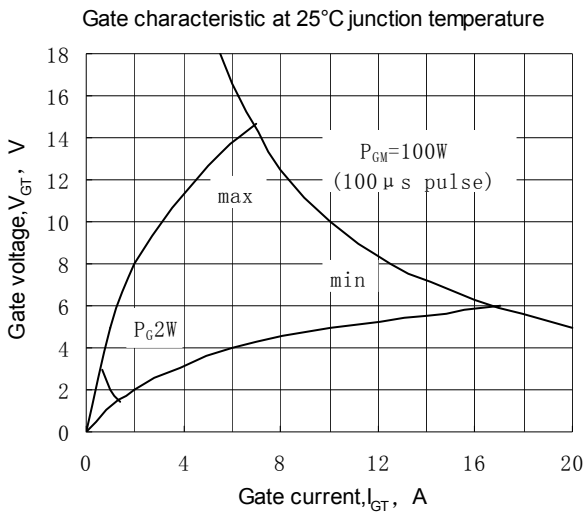

Fig.9

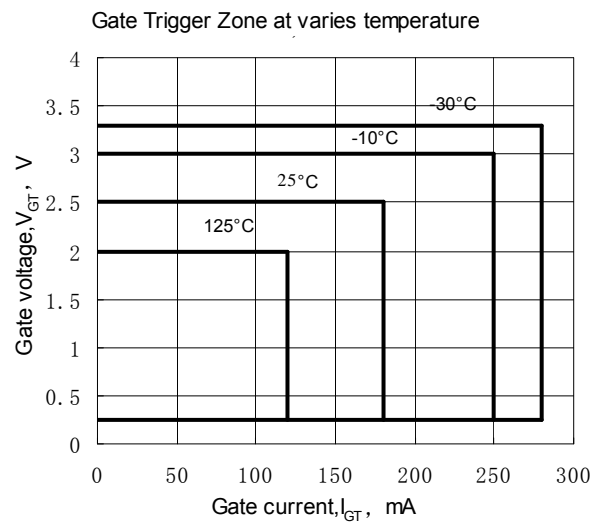
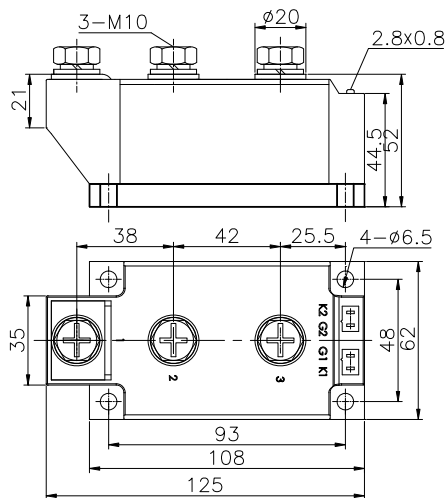

Fig.10

### Outline:



415F3

