

Features:

- Isolated mounting base 2500V
- Solder joint technology
- Space and weight savings

Typical Applications

- DC Power supplies for equipments.
- DC supply for PWM inverter
- Inverter Welder

I_o	150A
V_{RRM}	600~1800V
I_{FSM}	$2.1A \times 10^3$
I^2t	$22.1A^2 S \cdot 10^3$



SYMBOL	CHARACTERISTIC	TEST CONDITIONS	T _j (°C)	VALUE			UNIT
				Min	Type	Max	
I_o	DC output current	Single-phase full wave rectifying circuit, T _C =100°C	150			150	A
V_{RRM}	Repetitive peak reverse voltage	V _{RRM} tp=10ms V _{RSM} = V _{RRM} +100V	150	600		1800	V
I_{RRM}	Repetitive peak current	at V _{RRM}	150			15	mA
I_{FSM}	Surge forward current	10ms half sine wave	150			2.10	KA
I^2t	I ² T for fusing coordination	V _R =0.6V _{RRM}					22.1
V_{FO}	Threshold voltage		150			0.8	V
r_F	Forward slop resistance						3.8
V_{FM}	Peak forward voltage	I _{FM} =230A	25			1.38	V
$R_{th(j-c)}$	Thermal resistance Junction to case	Single side cooled				0.10	°C /W
$R_{th(c-h)}$	Thermal resistance case to heatsink	Single side cooled				0.07	°C /W
V_{iso}	Isolation voltage	50Hz, R.M.S, t=1min, I _{iso} :1mA(max)		2500			V
F_m	Terminal connection torque(M6)				6		N·m
	Mounting torque(M5)				4		N·m
T_{stg}	Stored temperature			-40		125	°C
W_t	Weight				420		g
Outline	411H5/221H5						

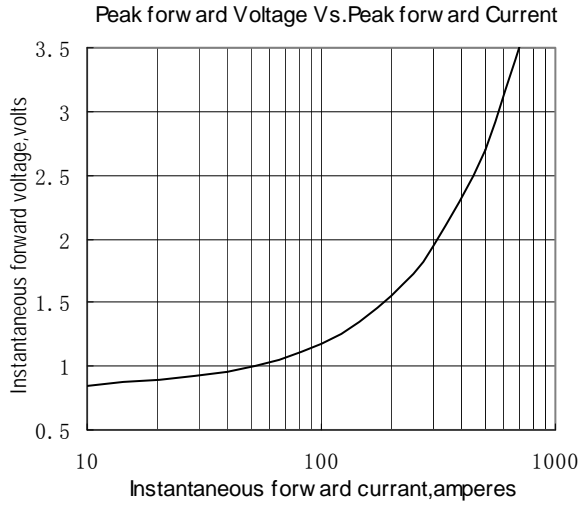

Fig.1

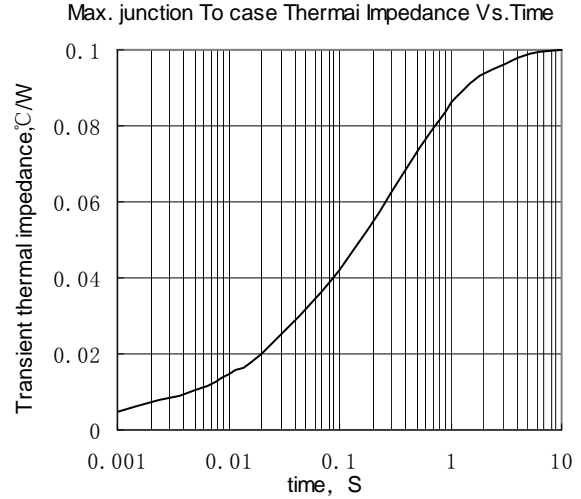

Fig.2

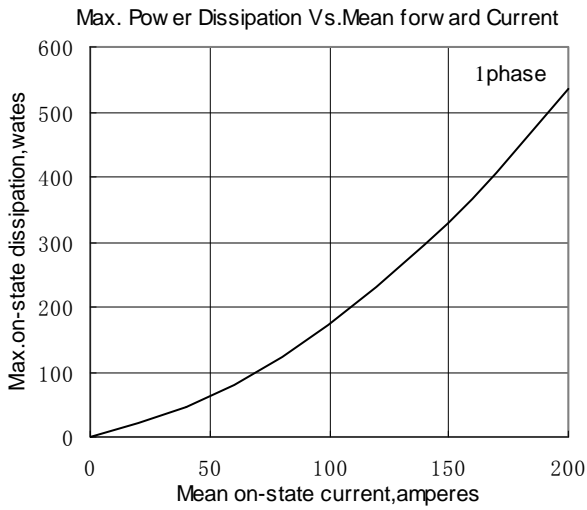

Fig.3

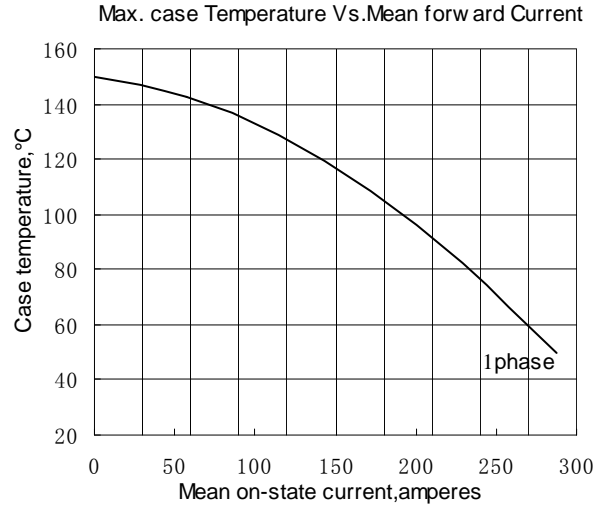

Fig.4

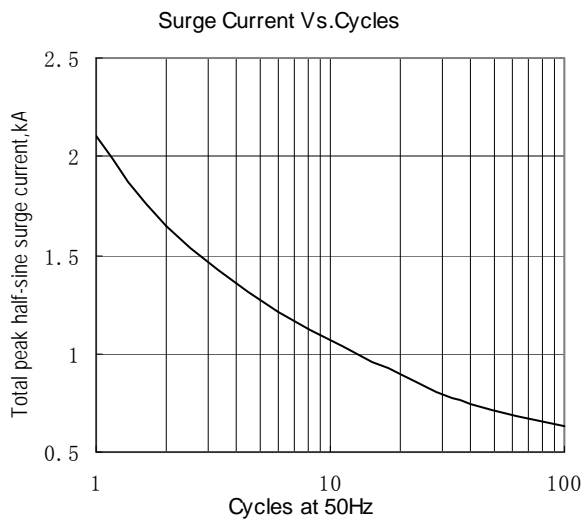

Fig.5

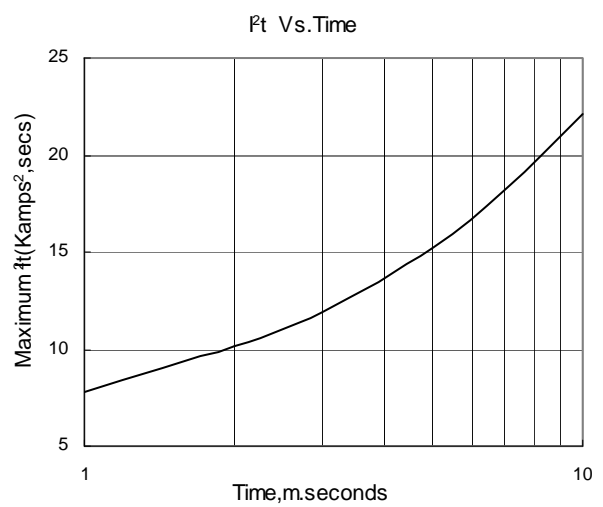
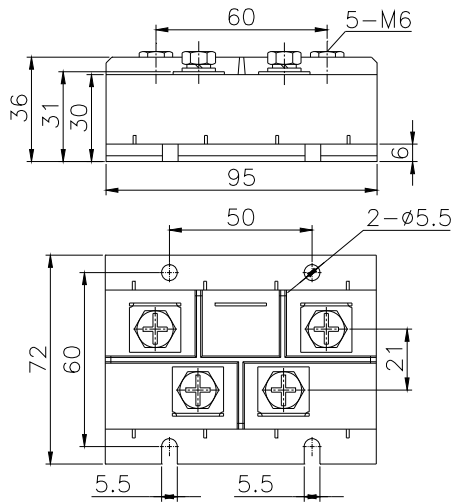

Fig.6

Outline:



411H5

