

Features:

- Isolated mounting base 2500V~
- Pressure contact technology with Increased power cycling capability
- Space and weight savings

Typical Applications

- Inverter
- Inductive heating
- Chopper

$I_{T(AV)}$ **300 A**
 V_{DRM} / V_{RRM} **600~1600 V**
 I_{TSM} **$7.30 A \times 10^3$**
 I^2t **$266 A^2 S \times 10^3$**



SYMBOL	CHARACTERISTIC	TEST CONDITIONS	T _j (°C)	VALUE			UNIT
				Min	Type	Max	
I _{T(AV)}	Mean on-state current	180° half sine wave 50Hz Single side cooled, T _c =85°C	115			300	A
I _{T(RMS)}	RMS on-state current		115			471	A
V _{DRM} V _{RRM}	Repetitive peak off-state voltage Repetitive peak reverse voltage	V _{DRM} &V _{RRM} tp=10ms V _{DSM} &V _{RSM} = V _{DRM} &V _{RRM} +100V respectively	115	600		1600	V
I _{DRM} I _{RRM}	Repetitive peak current	at V _{DRM} at V _{RRM}	115			80	mA
I _{TSM}	Surge on-state current	10ms half sine wave	115			7.30	KA
I ² t	I ² T for fusing coordination	V _R =60%V _{RRM}					266
V _{TO}	Threshold voltage		115			0.90	V
r _T	On-state slop resistance						0.74
V _{TM}	Peak on-state voltage	I _{TM} =900A	25			1.75	V
dv/dt	Critical rate of rise of off-state voltage	V _{DM} =67%V _{DRM}	115			800	V/μs
di/dt	Critical rate of rise of on-state current	Gate source 1.5A t _r ≤0.5μs Repetitive	115			200	A/μs
t _q	Circuit commutated turn-off time	I _{TM} = 300A, tp=1000μs, V _R =50V dv/dt=30V/μs , di/dt=-20A/μs	115	15		35	μs
t _{rr}	Reverse recovery time	I _{FM} =300A, tp=1000μs, -di/dt=20A/μs, V _R =50V	115		4.0		μs
I _{GT}	Gate trigger current	V _A =12V, I _A =1A	25	30		200	mA
V _{GT}	Gate trigger voltage			1.0		3.0	V
I _H	Holding current			20		100	mA
V _{GD}	Non-trigger gate voltage	V _{DM} = 67%V _{DRM}	115	0.2			V
R _{th(j-c)}	Thermal resistance Junction to case	Single side cooled				0.070	°C /W
R _{th(c-h)}	Thermal resistance case to heatsink	Single side cooled				0.04	°C /W
V _{iso}	Isolation voltage	50Hz, R.M.S, t=1min, I _{iso} : 1mA(MAX)		2500			V
F _m	Thermal connection torque(M10)				12		N·m
	Mounting torque(M6)				6		N·m
T _{stg}	Stored temperature			-40		125	°C
W _t	Weight				1350		g
Outline	415F3						

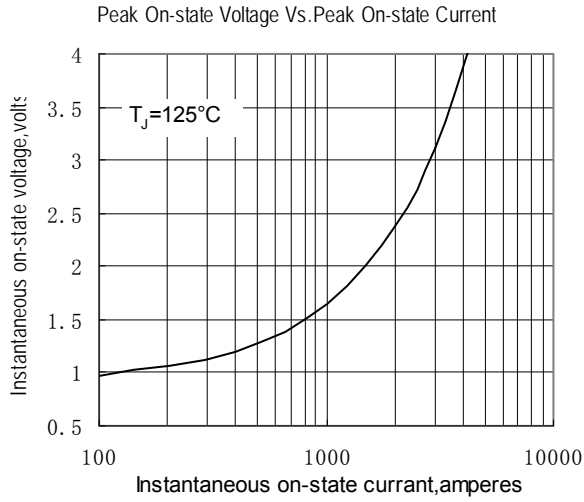

Fig.1

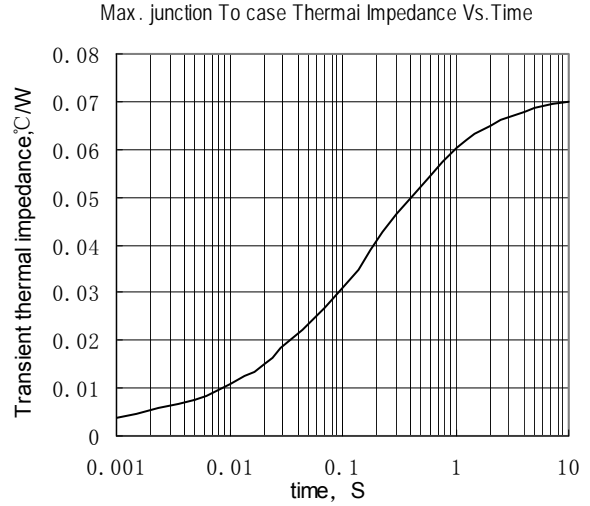

Fig.2

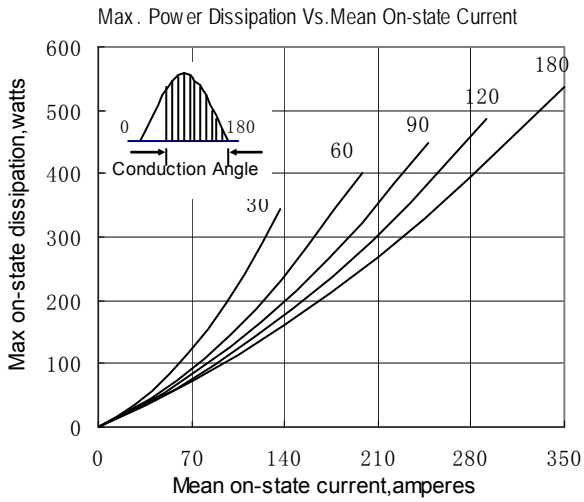

Fig.3

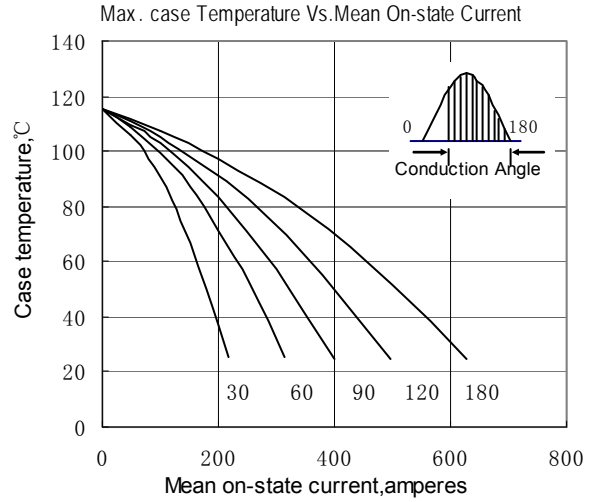

Fig.4

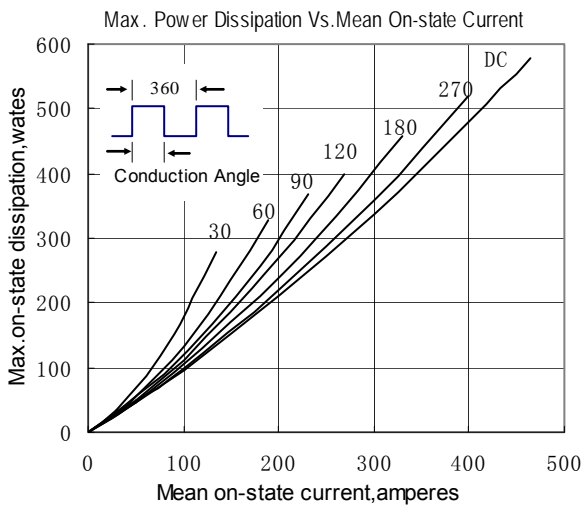

Fig.5

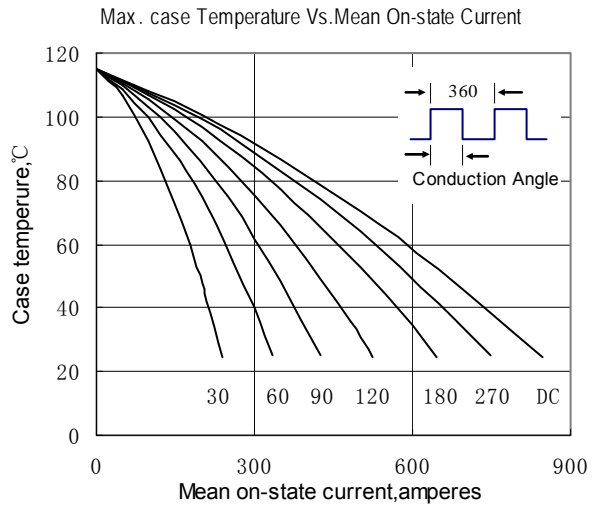

Fig.6

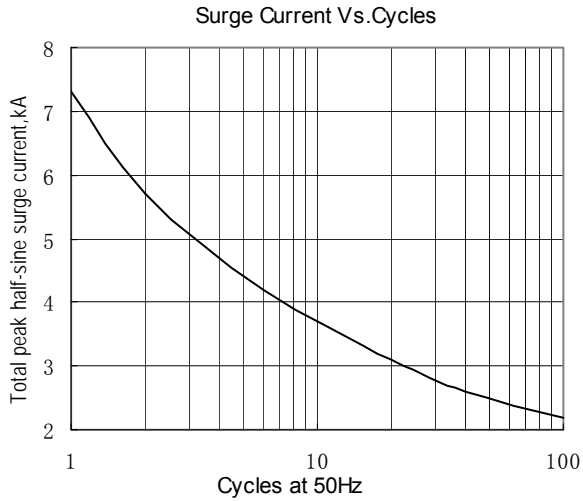

Fig.7

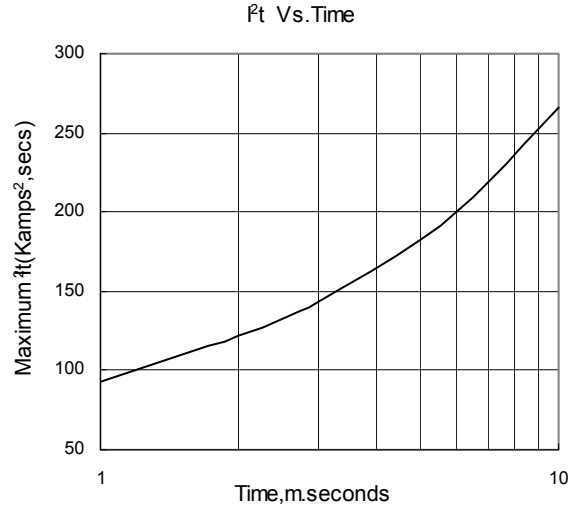

Fig.8

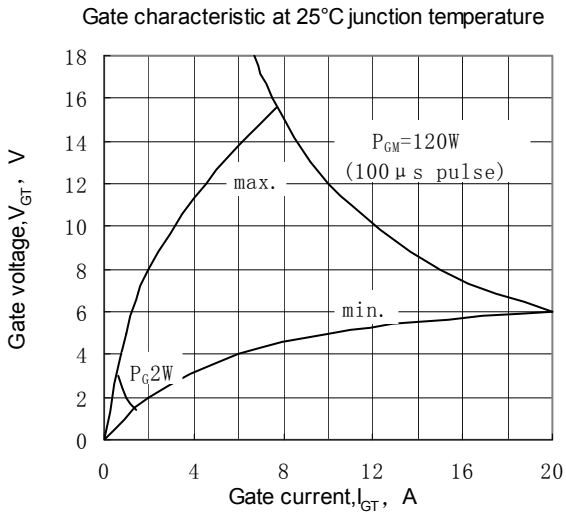

Fig.9

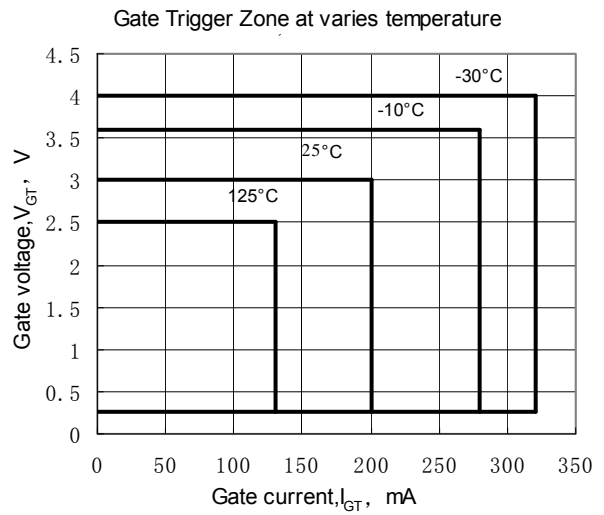
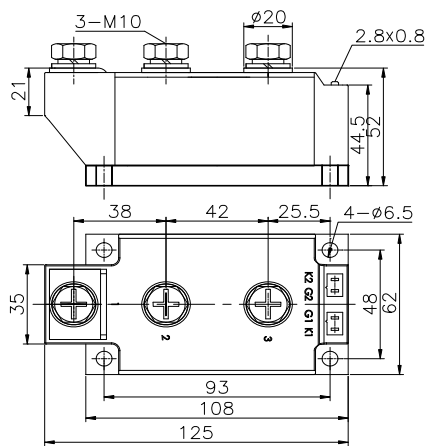

Fig.10

Outline:



415F3

