**Features:**

- n Non-isolated. Mounting base as common anode cathode terminal.
- n Pressure contact technology with Increased power cycling capability
- n Low forward voltage drop

Typical Applications:

- n Welding Power Supply
- n Various Dc power supplies

V _{RRM}	Type & Outline	
	Type	Outline
800V	MD300-08-407F2NA	MD300-08-407F2NK
1000V	MD300-10-407F2NA	MD300-10-407F2NK
1300V	MD300-12-407F2NA	MD300-12-407F2NK
1400V	MD300-14-407F2NA	MD300-14-407F2NK
1600V	MD300-16-407F2NA	MD300-16-407F2NK
1800V	MD300-18-407F2NA	MD300-18-407F2NK

SYMBOL	CHARACTERISTIC	TEST CONDITIONS	T _j (°C)	VALUE			UNIT
				Min	Type	Max	
I _{F(AV)}	Mean forward current	180° half sine wave 50Hz Single side cooled, T _c =100°C	150			300	A
I _{F(RMS)}	RMS forward current					471	A
I _{RRM}	Repetitive peak current	at V _{RRM}	150			10	mA
I _{FSM}	Surge forward current	V _R =60%V _{RRM} , t=10ms half sine	150			10	kA
I ² t	I ² t for fusing coordination					500	10 ³ A ² s
V _{FO}	Threshold voltage		150			0.80	V
r _F	Forward slope resistance					0.64	mΩ
V _{FM}	Peak forward voltage	I _{FM} =900A	25			1.50	V
R _{th(j-c)}	Thermal resistance Junction to case	Single side cooled per chip				0.13	°C/W
R _{th(c-h)}	Thermal resistance case to heatsink	Single side cooled per chip				0.04	°C/W
F _m	Terminal connection torque(M10)			10		12	N·m
	Mounting torque(M6)			4.5		6.0	N·m
T _{vj}	Junction temperature			-40		150	°C
T _{stg}	Stored temperature			-40		125	°C
W _t	Weight				330		g
Outline	407F2NA, 407F2NK						

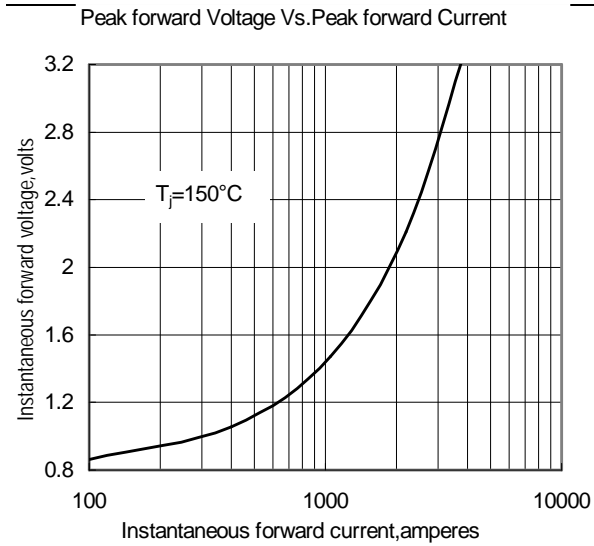

Fig.1

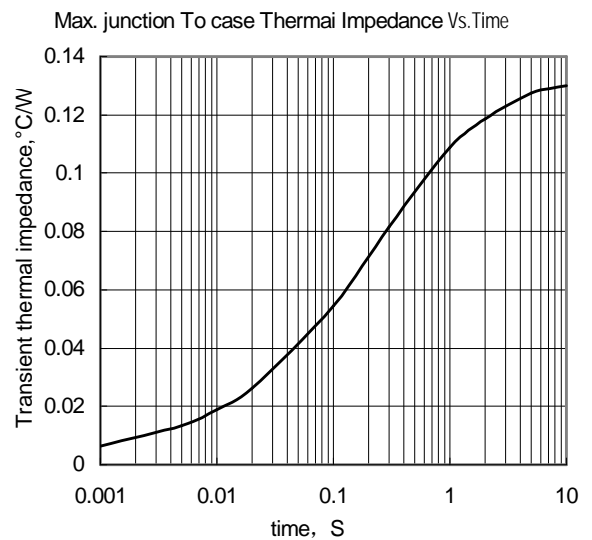

Fig.2

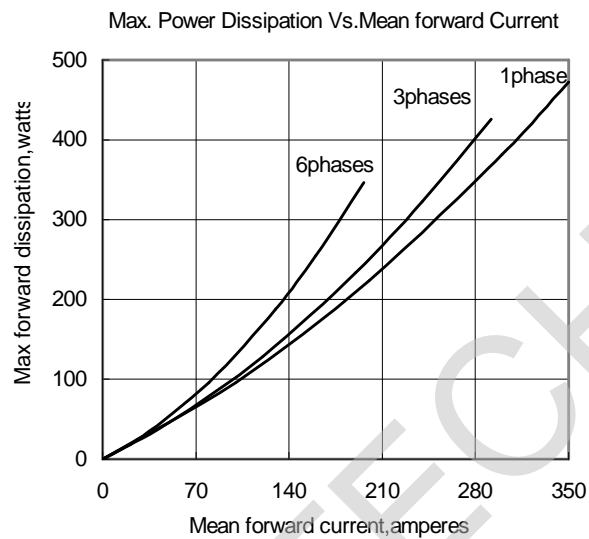

Fig.3

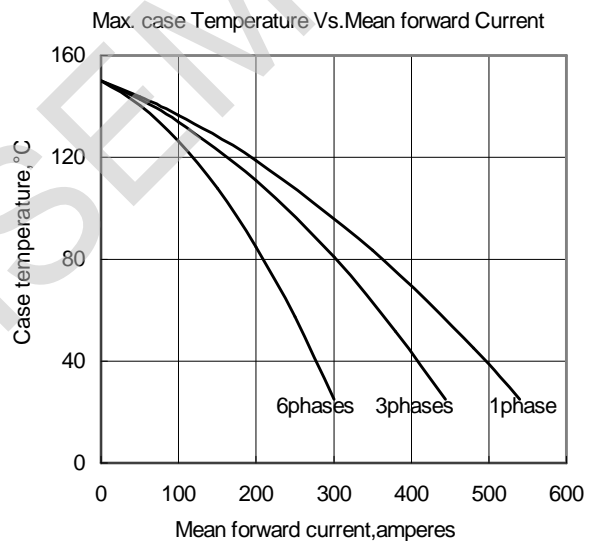

Fig.4

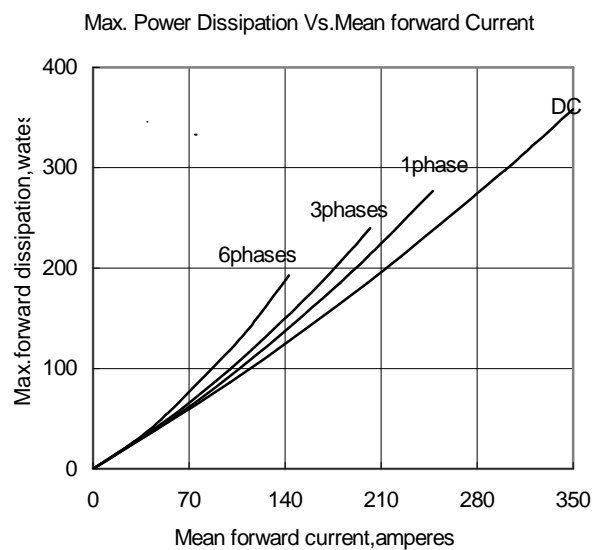

Fig.5

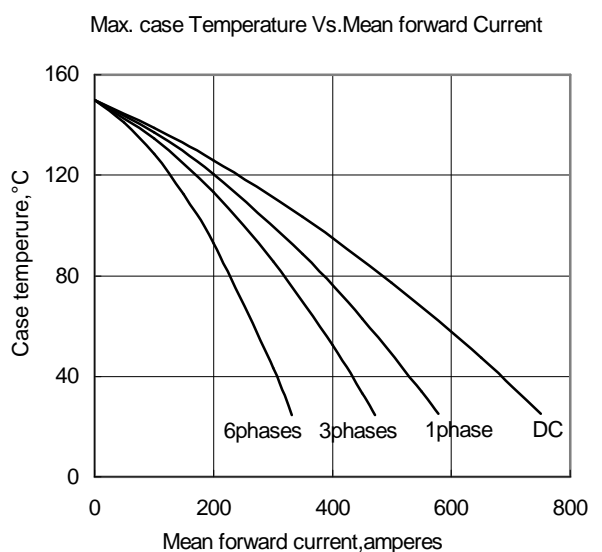

Fig.6

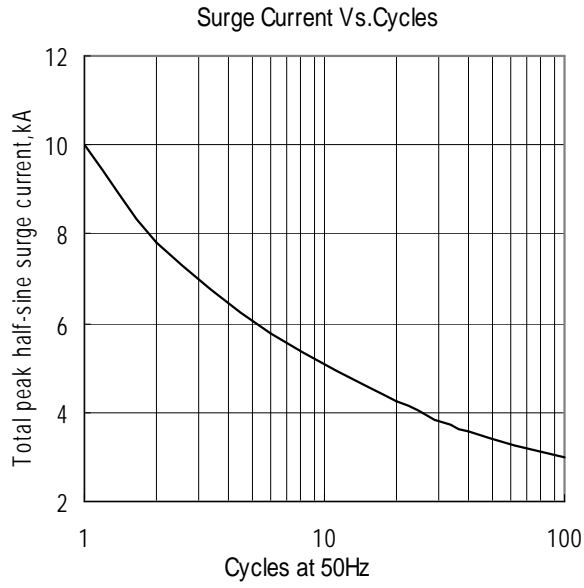

Fig.7

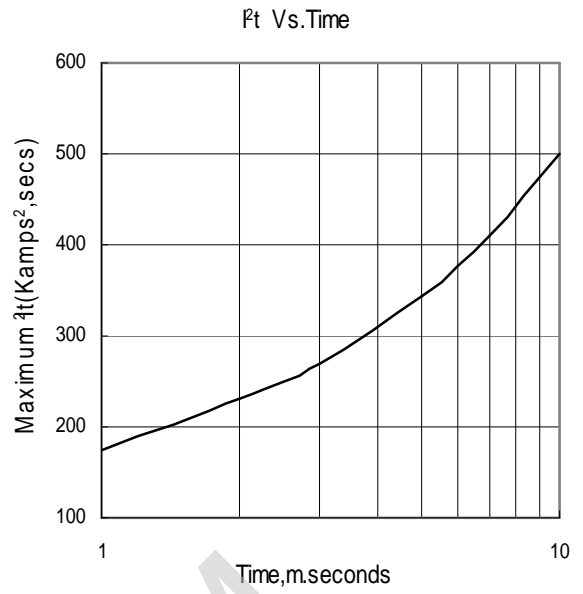
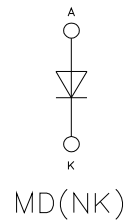
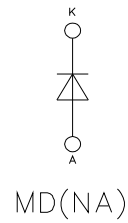
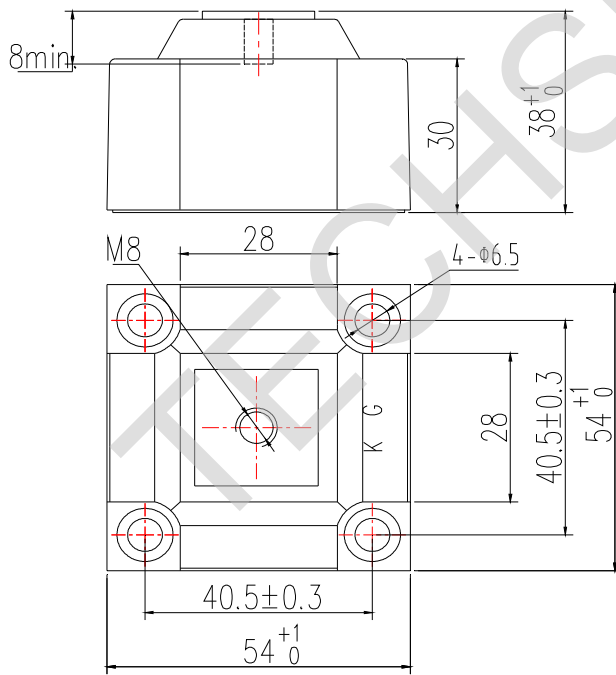

Fig.8

Outline:



Unmarked dimensional tolerance: ±0.5mm