

**Features:**

- n Isolated mounting base 3000V~
- n Pressure contact technology with Increased power cycling capability
- n Space and weight saving

**Typical Applications**

- n AC/DC Motor drives
- n Various rectifiers
- n DC supply for PWM inverter

V <sub>RRM</sub> , V <sub>DRM</sub>	Type & Outline
2000V	MFx135-20-216F3
2200V	MFx135-22-216F3
2500V	MFx135-25-216F3

MFx stands for any type of **MFC**, **MFA**, **MFK**

SYMBOL	CHARACTERISTIC	TEST CONDITIONS	T <sub>j</sub> (°C)	VALUE			UNIT
				Min	Type	Max	
I <sub>T(AV)</sub>	Mean on-state current	180° half sine wave 50Hz Single side cooled, T <sub>c</sub> =85°C	125			135	A
I <sub>T(RMS)</sub>	RMS on-state current					212	A
I <sub>DRM</sub> I <sub>RRM</sub>	Repetitive peak current	at V <sub>DRM</sub> at V <sub>RRM</sub>	125			20	mA
I <sub>TSM</sub>	Surge on-state current	V <sub>R</sub> =60%V <sub>RRM</sub> , t=10ms half sine.	125			3.6	kA
I <sup>2</sup> t	I <sup>2</sup> t for fusing coordination		125			65	10 <sup>3</sup> A <sup>2</sup> s
V <sub>TO</sub>	Threshold voltage		125			0.85	V
r <sub>T</sub>	On-state slope resistance					1.91	mΩ
V <sub>TM</sub>	Peak on-state voltage	I <sub>TM</sub> =410A	25			1.96	V
dv/dt	Critical rate of rise of off-state voltage	V <sub>DM</sub> =67%V <sub>DRM</sub>	125			1000	V/μs
di/dt	Critical rate of rise of on-state current	Gate source 1.5A t <sub>r</sub> ≤ 0.5μs Repetitive	125			200	A/μs
I <sub>GT</sub>	Gate trigger current	V <sub>A</sub> =12V, I <sub>A</sub> =1A	25	30		150	mA
V <sub>GT</sub>	Gate trigger voltage			0.7		2.5	V
I <sub>H</sub>	Holding current			10		200	mA
I <sub>L</sub>	Latching current					1000	mA
V <sub>GD</sub>	Non-trigger gate voltage	V <sub>DM</sub> =67%V <sub>DRM</sub>	125			0.20	V
R <sub>th(j-c)</sub>	Thermal resistance Junction to case	Single side cooled per chip				0.20	°C/W
R <sub>th(c-h)</sub>	Thermal resistance case to heatsink	Single side cooled per chip				0.08	°C/W
V <sub>iso</sub>	Isolation voltage	50Hz, R.M.S, t=1min, I <sub>iso</sub> : 1mA(MAX)		3000			V
F <sub>m</sub>	Terminal connection torque(M6)			4.5		6	N·m
	Mounting torque(M6)			4.5		6	N·m
T <sub>vj</sub>	Junction temperature			-40		125	°C
T <sub>stg</sub>	Stored temperature			-40		125	°C
W <sub>t</sub>	Weight				320		g
Outline	216F3						

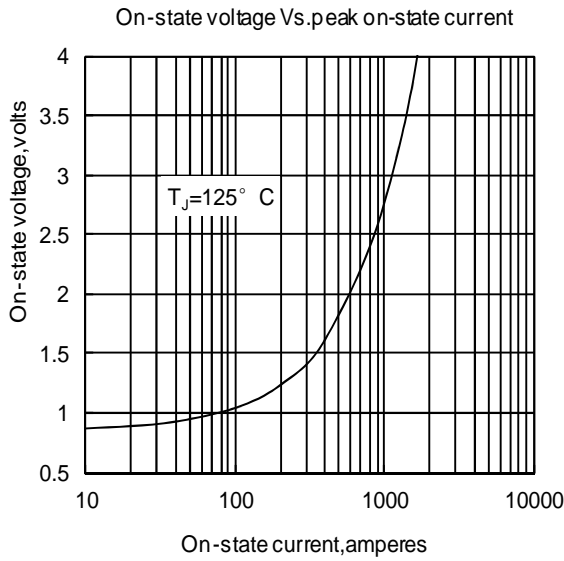

Fig. 1

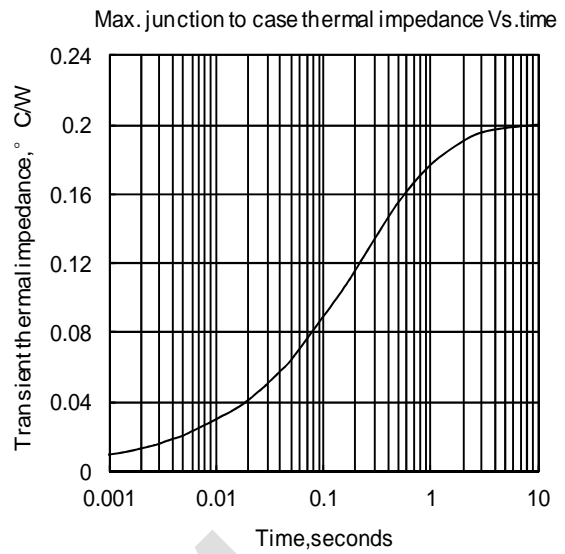

Fig. 2

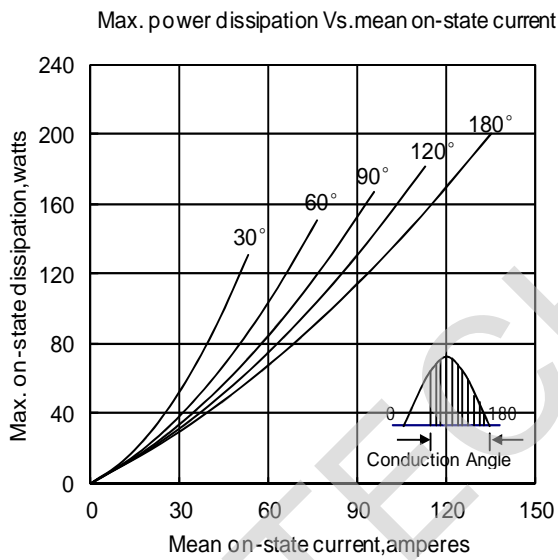

Fig. 3

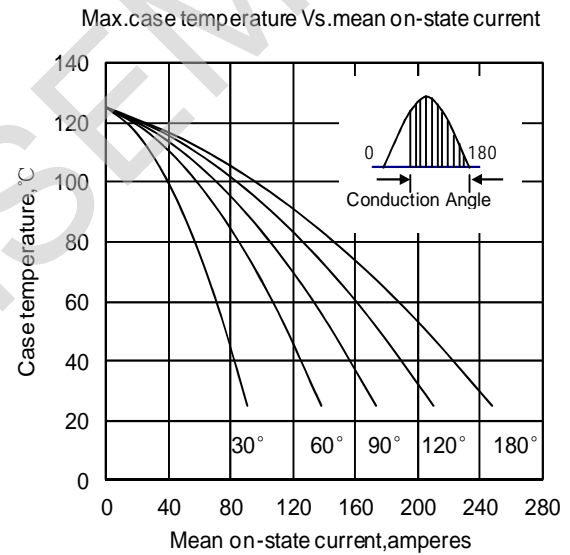

Fig. 4

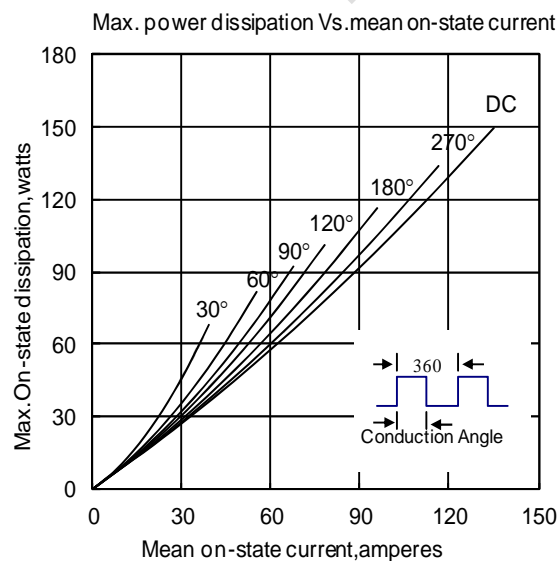

Fig. 5

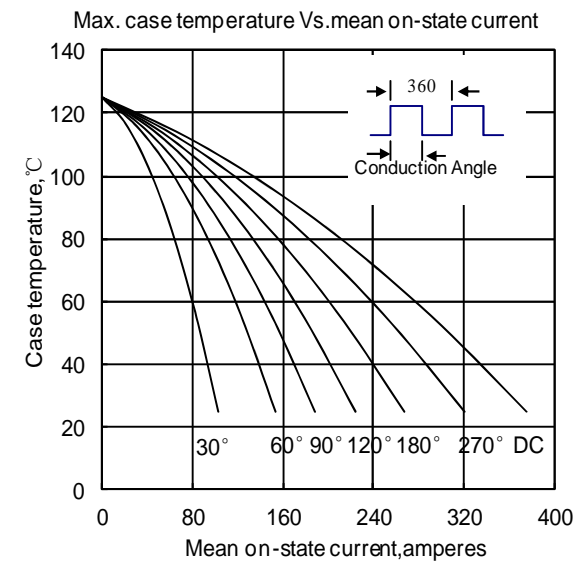

Fig. 6

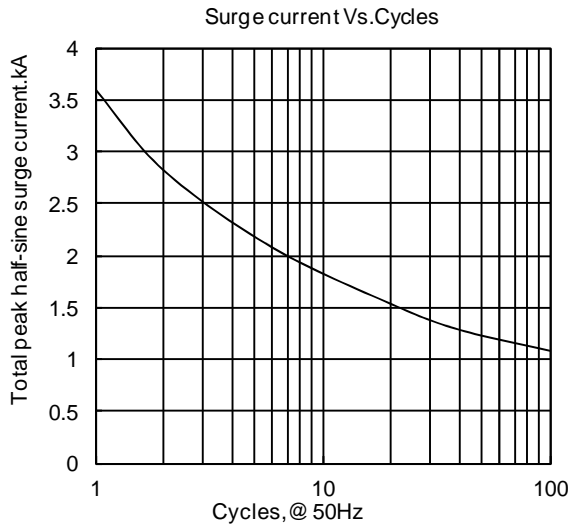

Fig. 7

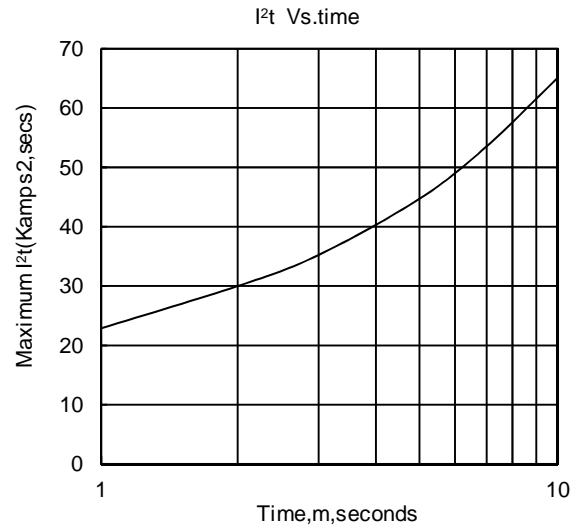

Fig. 8

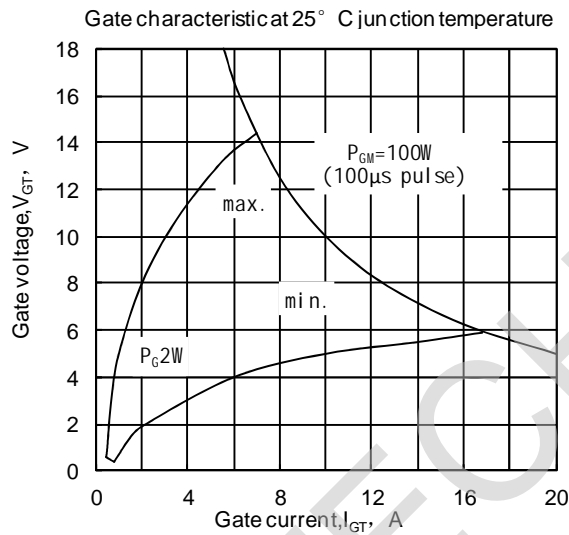

Fig. 9

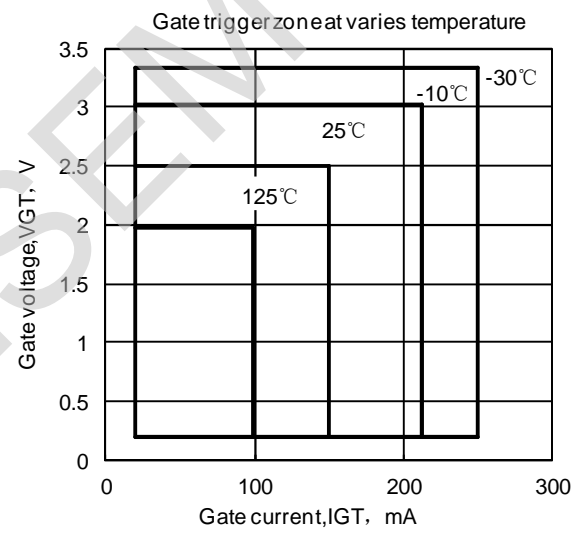
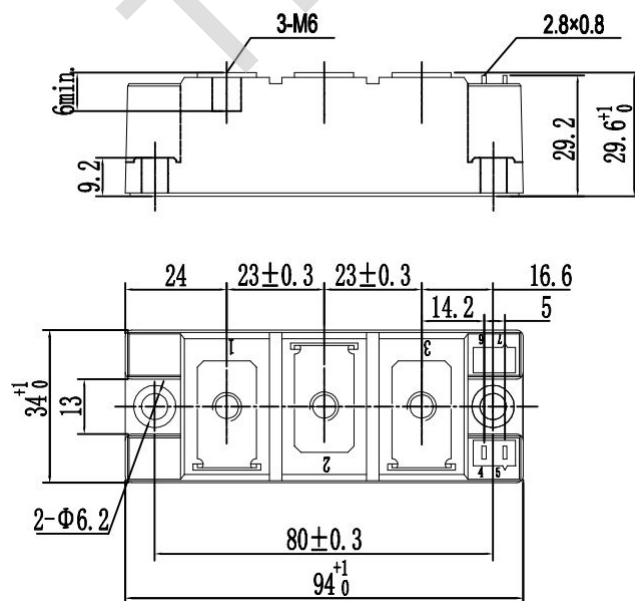

Fig. 10

Outline:



Unmarked dimensional tolerance: ±0.5mm

TECHSEM reserves the right to change specifications without notice.

