

**Features**

- n Center amplifying gate
- n Metal case with ceramic insulator
- n Low on-state and switching losses

**Typical Applications**

- n AC controllers
- n DC and AC motor control
- n Controlled rectifiers

**Part No. Y55KPE-KT54cT**

<b>I<sub>T(AV)</sub></b>	<b>1760A</b>
<b>V<sub>DRM</sub>, V<sub>RRM</sub></b>	<b>1200V 1400V</b>
	<b>1600V 1800V</b>

SYMBOL	CHARACTERISTIC	TEST CONDITIONS	T <sub>j</sub> (°C)	VALUE			UNIT
				Min	Type	Max	
I <sub>T(AV)</sub>	Mean on-state current	180° half sine wave 50Hz Double side cooled, T <sub>C</sub> =70°C	125			1760	A
V <sub>DRM</sub> V <sub>RRM</sub>	Repetitive peak off-state voltage Repetitive peak reverse voltage	tp=10ms	125	1100		1800	V
I <sub>DRM</sub> I <sub>RRM</sub>	Repetitive peak current	at V <sub>DRM</sub> at V <sub>RRM</sub>	125			100	mA
I <sub>TSM</sub>	Surge on-state current	10ms half sine wave	125			26	kA
I <sup>2</sup> t	I <sup>2</sup> t for fusing coordination	V <sub>R</sub> =0.6V <sub>RRM</sub>				3380	A <sup>2</sup> s*10 <sup>3</sup>
V <sub>TO</sub>	Threshold voltage		125			0.95	V
r <sub>T</sub>	On-state slope resistance					0.18	mΩ
V <sub>TM</sub>	Peak on-state voltage	I <sub>TM</sub> =3000A, F=26kN	25			2.00	V
dv/dt	Critical rate of rise of off-state voltage	V <sub>DM</sub> =0.67V <sub>DRM</sub>	125			1000	V/μs
di/dt	Critical rate of rise of on-state current	V <sub>DM</sub> = 67%V <sub>DRM</sub> to2500A, Gate pulse t <sub>r</sub> ≤0.5μs I <sub>GM</sub> =1.5A	125			200	A/μs
Q <sub>rr</sub>	Recovery charge	I <sub>TM</sub> =1000A, tp=4000μs, di/dt=-20A/μs, V <sub>R</sub> =100V	125		1500		μC
I <sub>GT</sub>	Gate trigger current	V <sub>A</sub> =12V, I <sub>A</sub> =1A	25	40		300	mA
V <sub>GT</sub>	Gate trigger voltage			0.8		3.0	V
I <sub>H</sub>	Holding current			20		300	mA
I <sub>L</sub>	Latching current					1000	mA
V <sub>GD</sub>	Non-trigger gate voltage	V <sub>DM</sub> =67%V <sub>DRM</sub>	125			0.3	V
R <sub>th(j-c)</sub>	Thermal resistance Junction to case	At 180° sine- double side cooled Clamping force 26kN				0.018	°C /W
R <sub>th(c-h)</sub>	Thermal resistance case to heatsink					0.004	
F <sub>m</sub>	Mounting force			21		30	kN
T <sub>vj</sub>	Junction temperature			-40		125	°C
T <sub>stg</sub>	Stored temperature			-40		140	°C
W <sub>t</sub>	Weight				590		g
Outline	KT54cT						

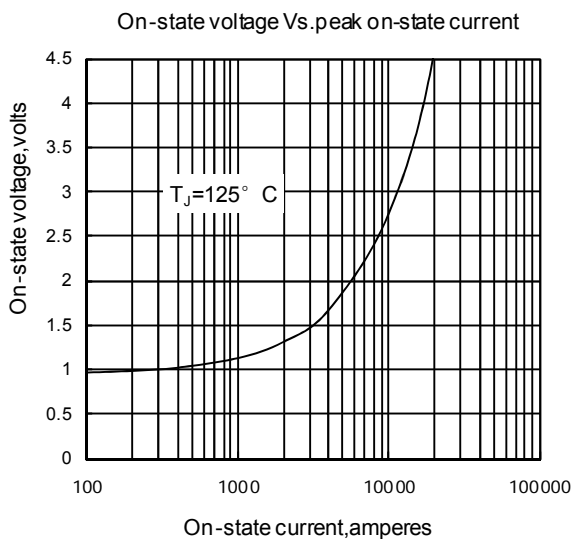

Fig1

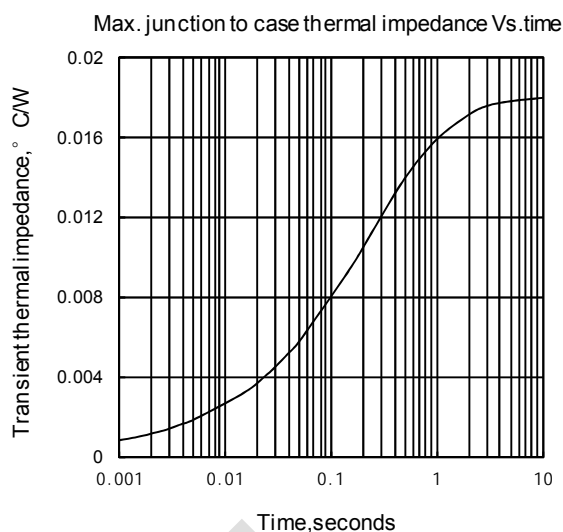

Fig2

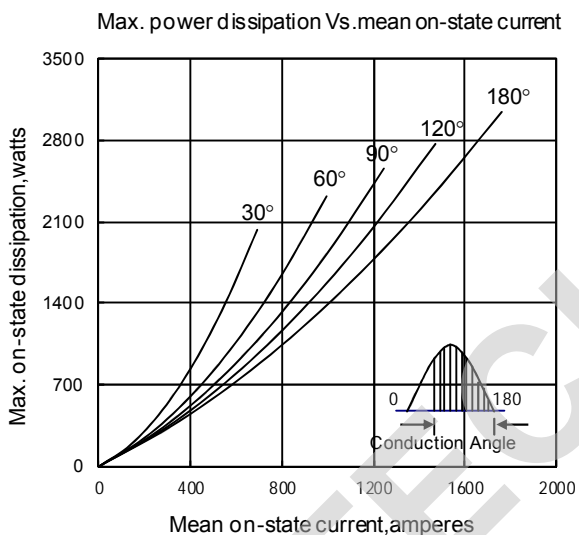

Fig3

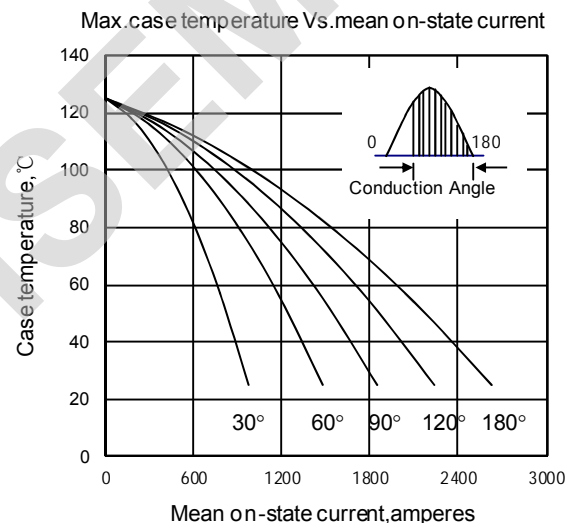

Fig4

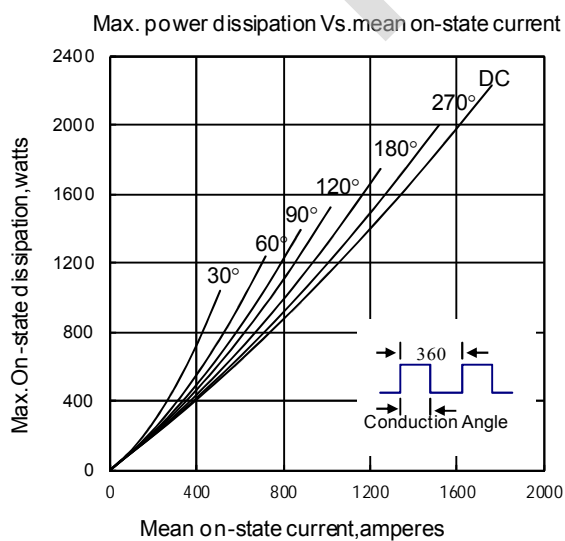

Fig5

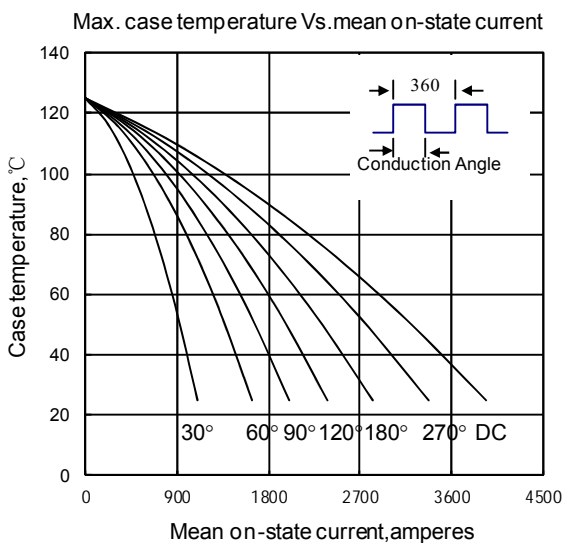

Fig6

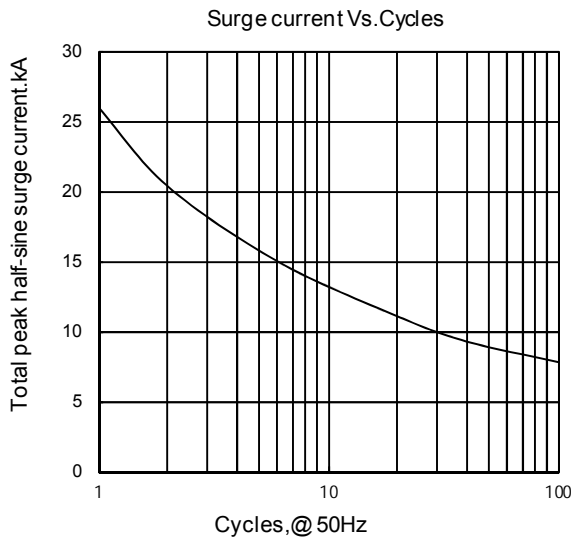

Fig7

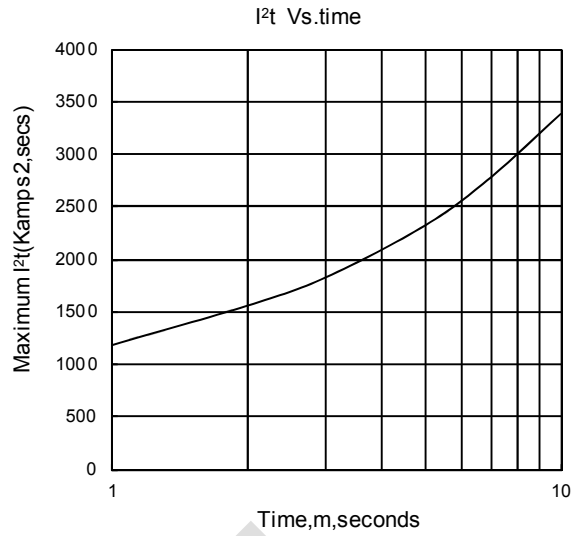

Fig8

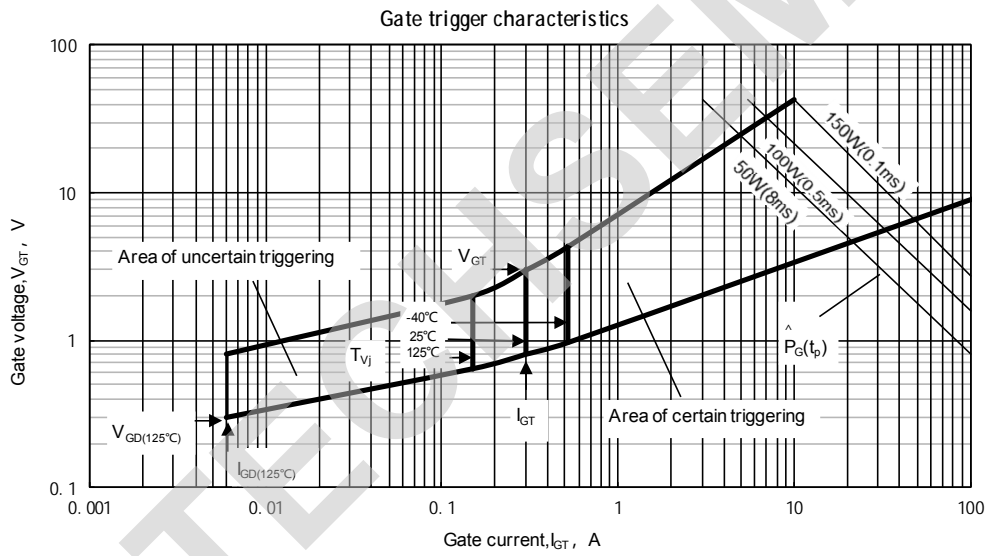
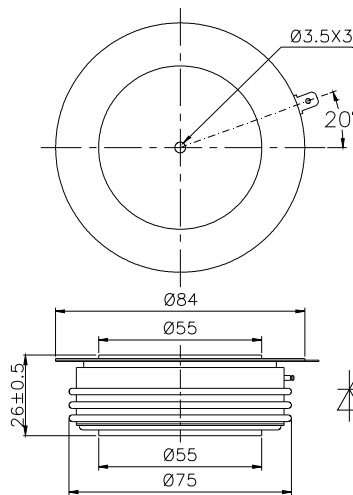

Fig.9

Outline:



TECHSEM reserves the right to change specifications without notice.