**Features:**

- n Low forward voltage drop
- n High reverse voltage
- n Hermetic metal cases with ceramic insulators

Typical Applications

- n All purpose high power rectifier diodes
- n High power resistance welding equipment
- n Non-controllable and half-controllable rectifiers
- n Controlled rectifiers

Part No. Y60ZPE-ZT54cT		
I_{F(AV)}	2500A	
V_{RRM}	3200V	3500V
	3800V	4000V
	4200V	

SYMBOL	CHARACTERISTIC	TEST CONDITIONS		T _j (°C)	VALUE			UNIT
					Min	Type	Max	
I _{F(AV)}	Mean forward current	180° half sine wave 50Hz Double side cooled,	T _C =85°C	160			2500	A
V _{RRM}	Repetitive peak reverse voltage	tp=10ms		160	3200		4200	V
I _{RRM}	Repetitive peak current	at V _{RRM}		160			120	mA
I _{FSM}	Surge forward current	10ms half sine wave		160			22	kA
I ² t	I ² t for fusing coordination	V _R =0.6V _{RRM}					2420	A ² s*10 ³
V _{FO}	Threshold voltage			160			0.90	V
r _F	Forward slope resistance						0.125	mΩ
V _{FM}	Peak forward voltage	I _{FM} =4000A, F=35kN		25			1.60	V
Q _{rr}	Recovery charge	I _{FM} =2000A, tp=4000μs, di/dt=-20A/μs, V _R =100V		160		4600		μC
R _{th(j-c)}	Thermal resistance Junction to case	At 180° sine double side cooled Clamping force 28kN					0.016	°C/W
R _{th(c-h)}	Thermal resistance case to heat sink						0.004	
F _m	Mounting force				21		30	kN
T _{vj}	Junction temperature				-40		160	°C
T _{stg}	Stored temperature				-40		160	°C
W _t	Weight					640		g
Outline	ZT54cT							

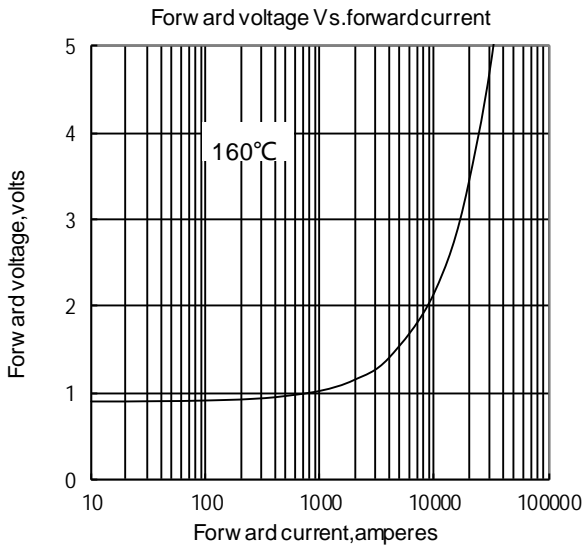

Fig.1

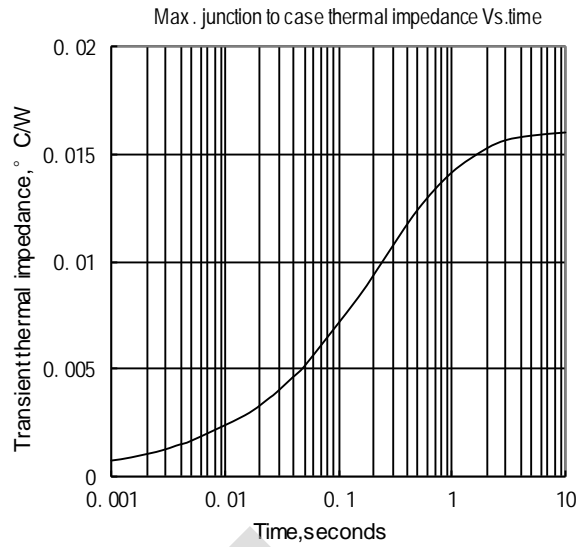

Fig.2

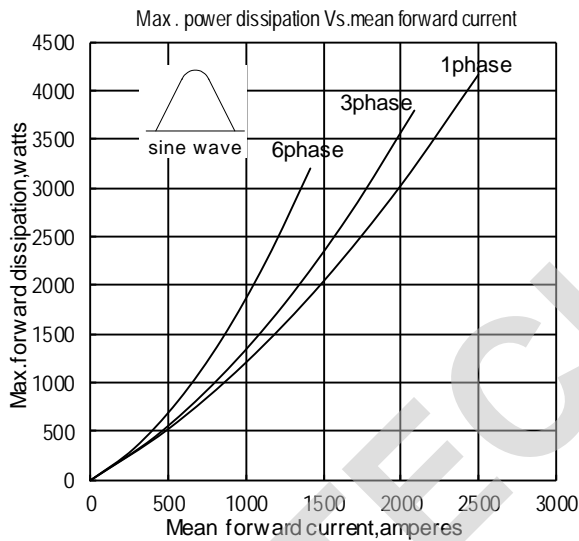

Fig.3

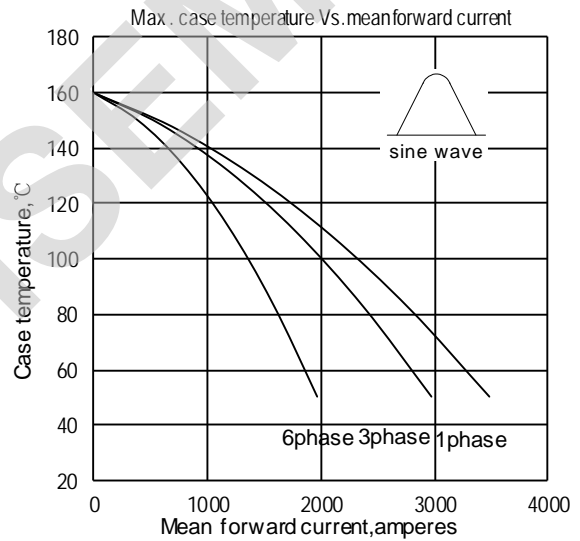

Fig.4

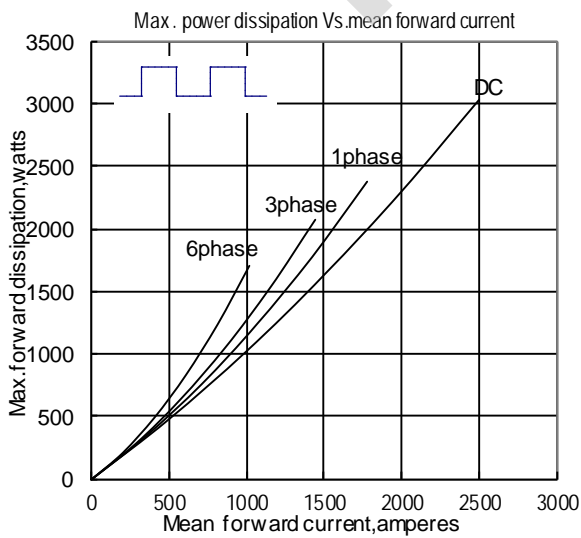

Fig.5

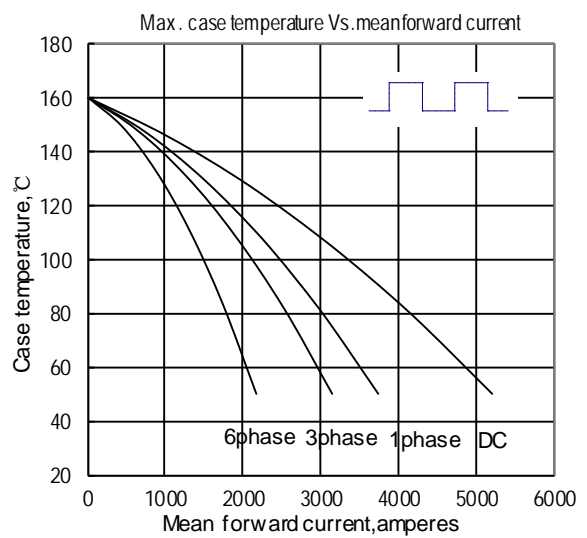

Fig.6

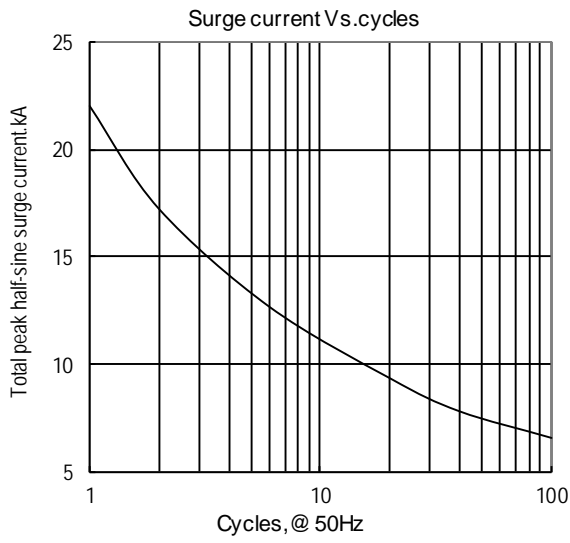

Fig.7

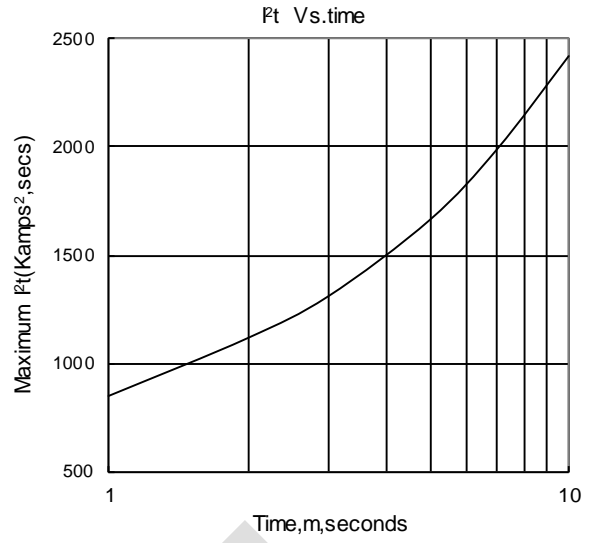
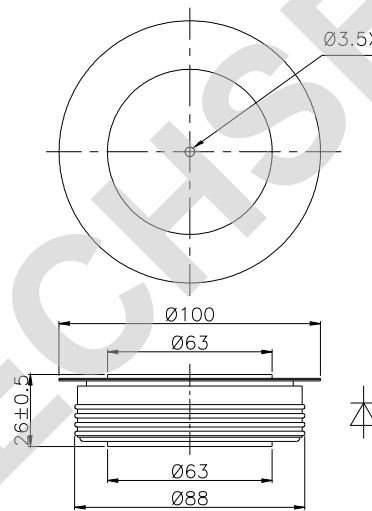

Fig.8

Outline:



TECHSEM reserves the right to change specifications without notice.